

Noble Travails: Noble Liquid Dark Matter Detectors

Rick Gaitskell

Particle Astrophysics Group, Brown University, Department of Physics

(Supported by US DOE HEP)

see information at

<http://particleastro.brown.edu/>

<http://gaitskell.brown.edu>

Dark Matter Theory and Experiment

- SOME SUSY MODELS

- [blue] T. Baltz and P. Gondolo, Markov Chain Monte Carlos. JHEP 0410 (2004) 052, (hep-ph/0407039)
- [red] J. Ellis et al. CMSSM, Phys.Rev. D71 (2005) 095007, (hep-ph/0502001)
- [red crosses] G.F. Giudice and A. Romanino, Nucl.Phys. B699 (2004) 65; Erratum-ibid. B706 (2005) 65, (hep-ph/0406088)
- [blue crosses] A. Pierce, Finely Tuned MSSM, Phys.Rev. D70 (2004) 075006, (hep-ph/0406144)

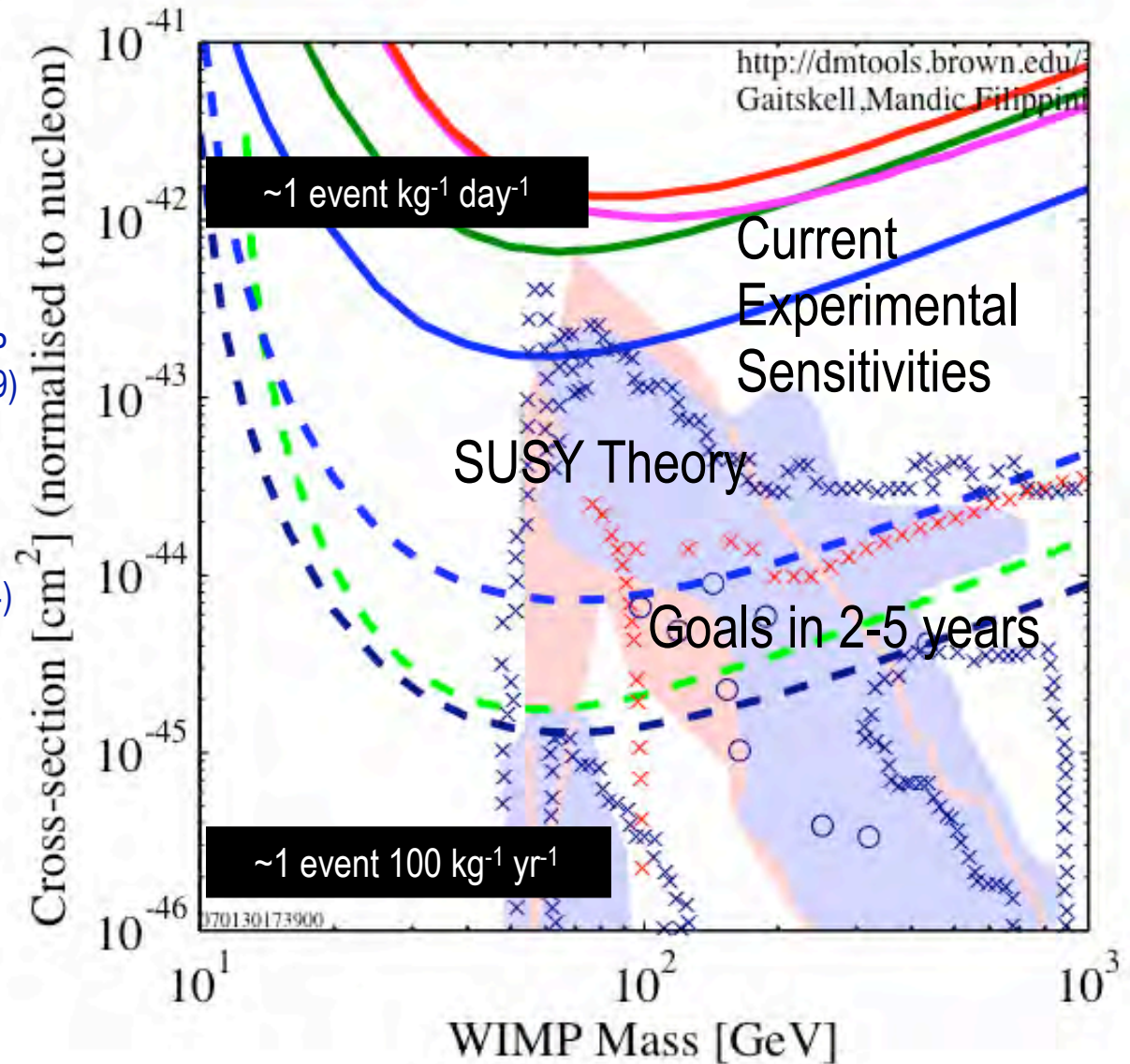

Background Challenges

- Search sensitivity (low energy region $\ll 100$ keV)
 - Current Exp Limit < 1 evt/kg/20 days, $\sim < 10^{-1}$ evt/kg/day
 - Goal < 1 evt/tonne/year, $\sim < 10^{-5}$ evt/kg/day
- Activity of typical Human
 - ~ 10 kBq (10^4 decays per second, 10^9 decays per day)
- Environmental Gamma Activity in unshielded detector
 - 10^7 evt/kg/day (all values integrated 0–100 keV)
 - This can be easily reduced to $\sim 10^2$ evt/kg/day using 25 cm of Pb
- Moving beyond this
 - e.g. High Purity Water Shield 4m gives $\ll 1$ evt/kg/day
 - But you have to focus on intrinsic U/Th contamination ppt (10^{-12} g/g) levels
- Main technique to date focuses on nuclear vs electron recoil discrimination
 - This is how CDMS II experiment went from $10^2 \rightarrow 10^{-1}$ evts/kg/day
- Environmental Neutron Activity
 - (α, n) from rock $0.1 \text{ cm}^{-2} \text{ day}^{-1}$
 - Since < 8 MeV use standard moderators (e.g. polyethylene, or water, $0.1 \times$ flux per 10 cm)
 - Cosmic Ray Muons generate high energy neutrons 50 MeV - 3 GeV which are tough to moderate
 - Need for depth (DUSEL) - surface muon 1/hand/sec, Homestake 4850 ft 1/hand/month



Techniques for dark matter direct detection

TYPE	DISCRIMINATION TECHNIQUE	TYPICAL EXPERIMENT	ADVANTAGE
Ionization	None (Ultra Low BG)	MAJORANA, GERDA	Searches for $\beta\beta$ -decay, dm additional
Solid Scintillator	pulse shape discrimination	LIBRA/DAMA, NAIAD	low threshold, large mass, but poor discrim
Cryogenic	charge/phonon light/phonon	CDMS, CRESST EDELWEISS	demonstrated bkg discrim., low threshold, but smaller mass/higher cost
Liquid noble gas	light pulse shape discrimination, and/or charge/light	ArDM, LUX, WARP, XENON, XMASS, XMASS-DM, ZEPLIN	large mass, good bkg discrimination
Bubble chamber	super-heated bubbles/droplets	COUPP, PICASSO	large mass, good bkg discrimination
Gas detector	ionization track resolved	DRIFT	directional sensitivity, good discrimination

Noble Liquids

- Why Noble Liquids?
 - Nuclear vs Electron Recoil discrimination readily achieved
 - Scintillation pulse shapes
 - Ionization/Scintillation Ratio
 - High Scintillation Light Yields
 - Low energy thresholds can be achieved (although have to pay close attention to how discrimination behaves with energy)
 - Ionization Drift $\gg 1$ m, at purities achieved (\ll ppm electronegative impurities)
 - Large Detector Masses are easily constructed and behave well
 - Shelf shielding means Inner Fiducial volumes have very low activity (assuming intrinsic activity of target material is low)
 - BG models get better the larger the instrument
 - Position resolution of events very good in TPC operation (ionization)
 - Dark matter cross section on nucleons goes down at least to $\sigma \sim 10^{-46} \text{ cm}^2 \Rightarrow 1 \text{ event}/100 \text{ kg}/\text{year}$ (in Ge or Xe), so need a large fiducial mass to collect statistics
 - Cost & Practicality of Large Instruments
 - Very competitive / Simply Increase PMTs
- “Dark Matter Sensitivity Scales As The Mass, Problems Scale As The Surface Area”

Noble Liquids as detector medium

	Z (A)	BP (T _b) at 1 atm [K]	liquid density at T _b [g/cc]	ionization [e-/MeV]	scintillation [photon/MeV]
He	2 (4)	4.2	0.13	39,000	22,000
Ne	10 (20)	27.1	1.21	46,000	30,000
Ar	18 (40)	87.3	1.40	42,000	40,000
Kr	36 (84)	119.8	2.41	49,000	25,000
Xe	54 (131)	165.0	3.06	64,000	46,000

- Scintillation Light Yield comparable to NaI 40,000 phot/MeV
- liquid rare gas gives both scintillation and ionization signals

Noble Liquids as detector medium

	Z (A)	BP (T _b) at 1 atm [K]	liquid density at T _b [g/cc]	ionization [e-/keV]	scintillation [photon/keV]
He	2 (4)	4.2	0.13	39	22
Ne	10 (20)	27.1	1.21	46	30
Ar	18 (40)	87.3	1.40	42	40
Kr	36 (84)	119.8	2.41	49	25
Xe	54 (131)	165.0	3.06	64	46

- liquid rare gas gives both scintillation and ionization signals
- Scintillation is decreased (~factor 2) when E-field applied for extracting ionization

In LXe ~30% of electron recoil energy appears as scintillation light (7 eV photons)

Noble Liquid Comparison (DM Detectors)

	Scintillation Light	Intrinsic Backgrounds
Ne (A=20) \$60/kg 100% even-even nucleus	85 nm Requires wavelength Shifter	Low BP (20K) - all impurities frozen out No radioactive isotopes
Ar (A=40) \$2/kg (isotope separation >\$1000/kg) ~100% even-even	125 nm Requires wavelength shifter	Nat Ar contains ~39Ar 1 Bq/kg == ~150 evts/keVee/kg/day at low energies. Requires isotope separation, low 39Ar source, or very good discrimination (~10 ⁶ to match CDMS II)
Xe (A=131) \$800/kg 50% odd isotope	175 nm UV quartz PMT window	No long lived isotopes. 85Kr can be removed by charcoal or distillation.

Noble Liquid Comparison (DM Detectors)

	Scintillation Light	Intrinsic Backgrounds
Ne (A=20) \$60/kg 100% even-even nucleus	85 nm Requires wavelength shifter	
Ar (A=40) \$2/kg (isotope separation >\$1000/kg) ~100% even-even	125 nm Requires wavelength shifter	
Xe (A=131) \$800/kg 50% odd isotope	175 nm UV quartz window	

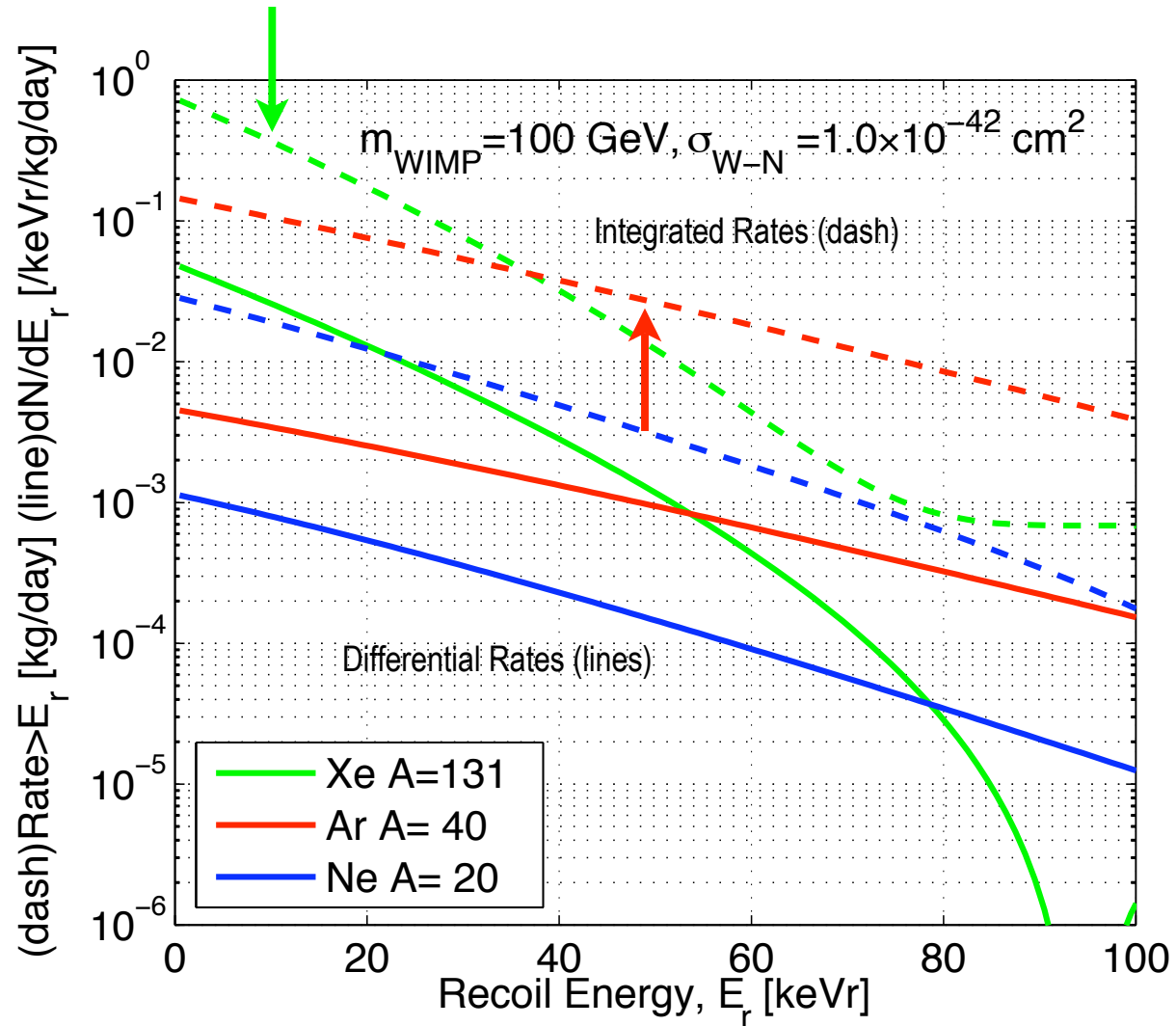

Noble Liquid Comparison (DM Detectors)

	Scintillation Light	Intrinsic Backgrounds	WIMP (100 GeV) Sensitivity vs Ge >10 keVr
<p>Ne (A=20) \$60/kg</p> <p>100% even-even nucleus</p>	<p>85 nm Requires wavelength Shifter</p>	<p>Low BP (20K) - all impurities frozen out</p> <p>No radioactive isotopes</p>	<p>Scalar Coupling: Eth>50 keVr, 0.02x</p> <p>Axial Coupling: 0 (no odd isotope)</p>
<p>Ar (A=40) \$2/kg (isotope separation >\$1000/kg) ~100% even-even</p>	<p>125 nm Requires wavelength shifter</p>	<p>Nat Ar contains ~39Ar 1 Bq/kg == ~150 evts/keVee/kg/day at low energies. Requires isotope separation, low 39Ar source, or very good discrimination (~10⁶ to match CDMS II)</p>	<p>Scalar Coupling: Eth>50 keVr, 0.10x</p> <p>Axial Coupling: 0 (no odd isotope)</p>
<p>Xe (A=131) \$800/kg</p> <p>50% odd isotope</p>	<p>175 nm UV quartz PMT window</p>	<p>No long lived isotopes. 85Kr can be removed by charcoal or distillation.</p>	<p>Scalar Coupling: Eth>10 keVr, 1.30x</p> <p>Axial Coupling: ~5x (model dep) Xe is 50% odd n isotope 129Xe, 131Xe</p>

Noble Liquid Detectors: Mechanism & Experiments

	Single phase (Liquid only) PSD	Double phase (Liquid + Gas) PSD/Ionization
Xenon	ZEPLIN I XMASS	ZEPLIN II+III, XENON, XMASS-DM, LUX
Argon	DEAP, CLEAN	WARP, ArDM
Neon	CLEAN	

- Single phase - scintillation only
 - e-ion recombination occurs
 - singlet/triplet ratio 10:1 nuclear:electron
- Double phase - ionization & scintillation
 - drift electrons in E-field (kV/cm)

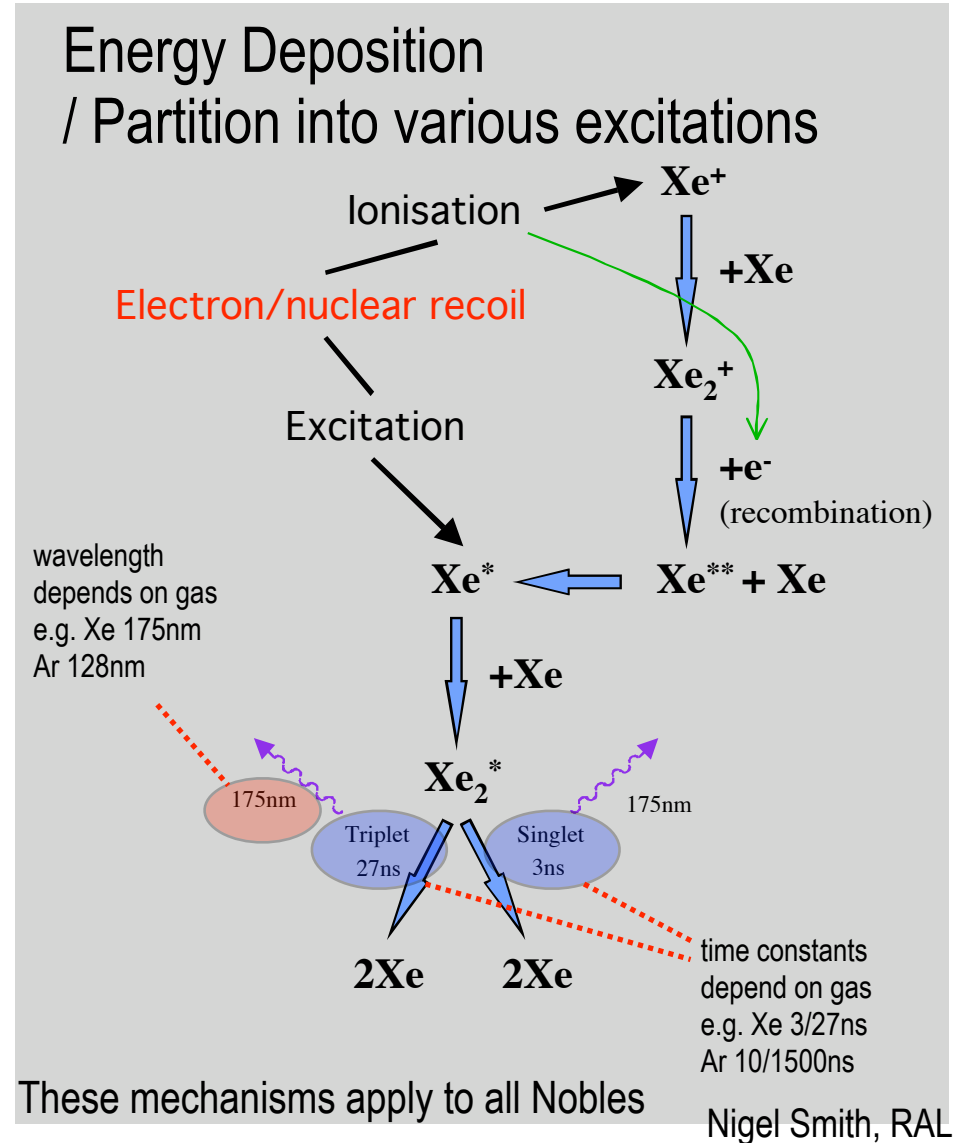

Data taken with Micro-CLEAN (McKinsey, Yale)

CLEAN Ar PSD

Time Dependence of Liquid Argon Scintillation

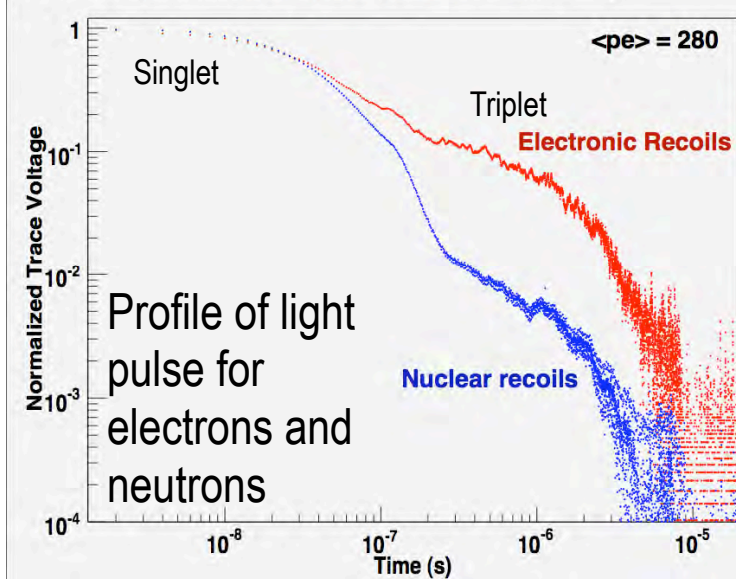

Scintillation Efficiency of Nuclear Recoils

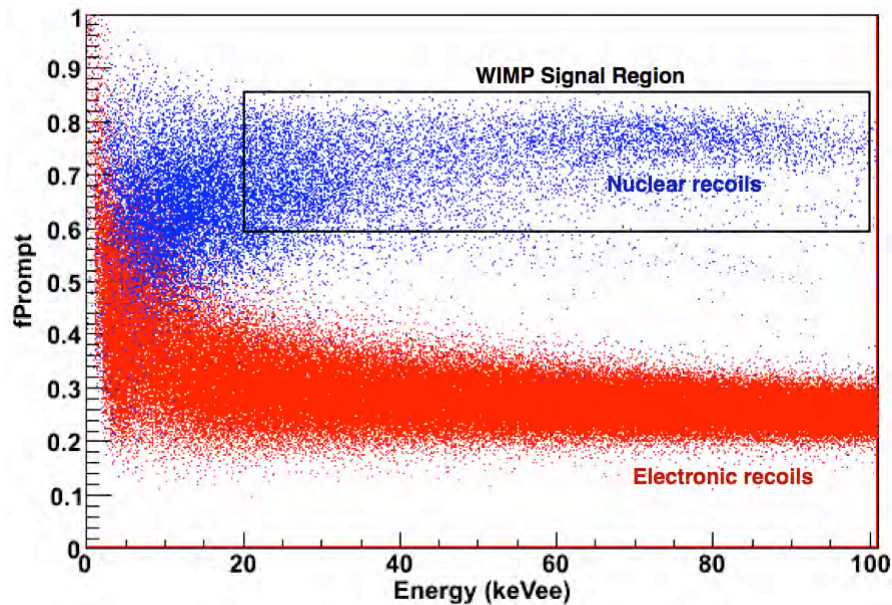
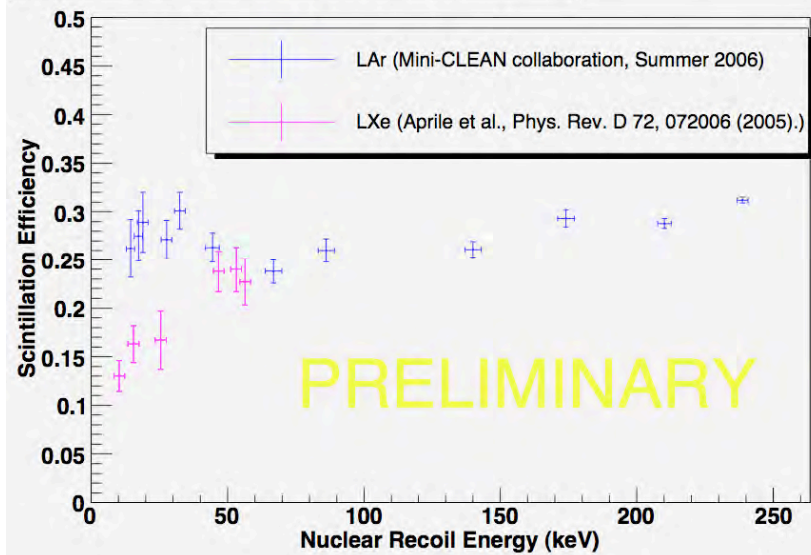

Discrimination in LAr is better than 99.999% above 50 keVr

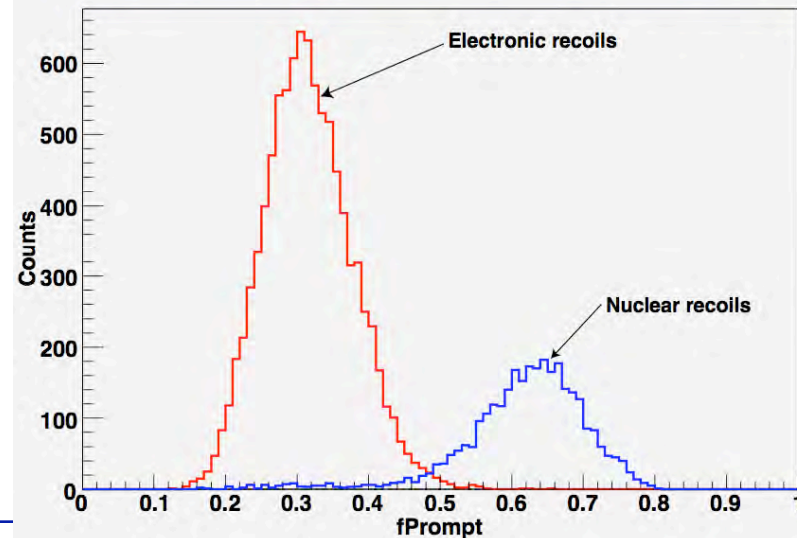

(McKinsey, Yale)

Gamma Ray - Nuclear Recoil Discrimination Efficiency vs Energy in LAr
Assumes 50% nuclear recoil acceptance

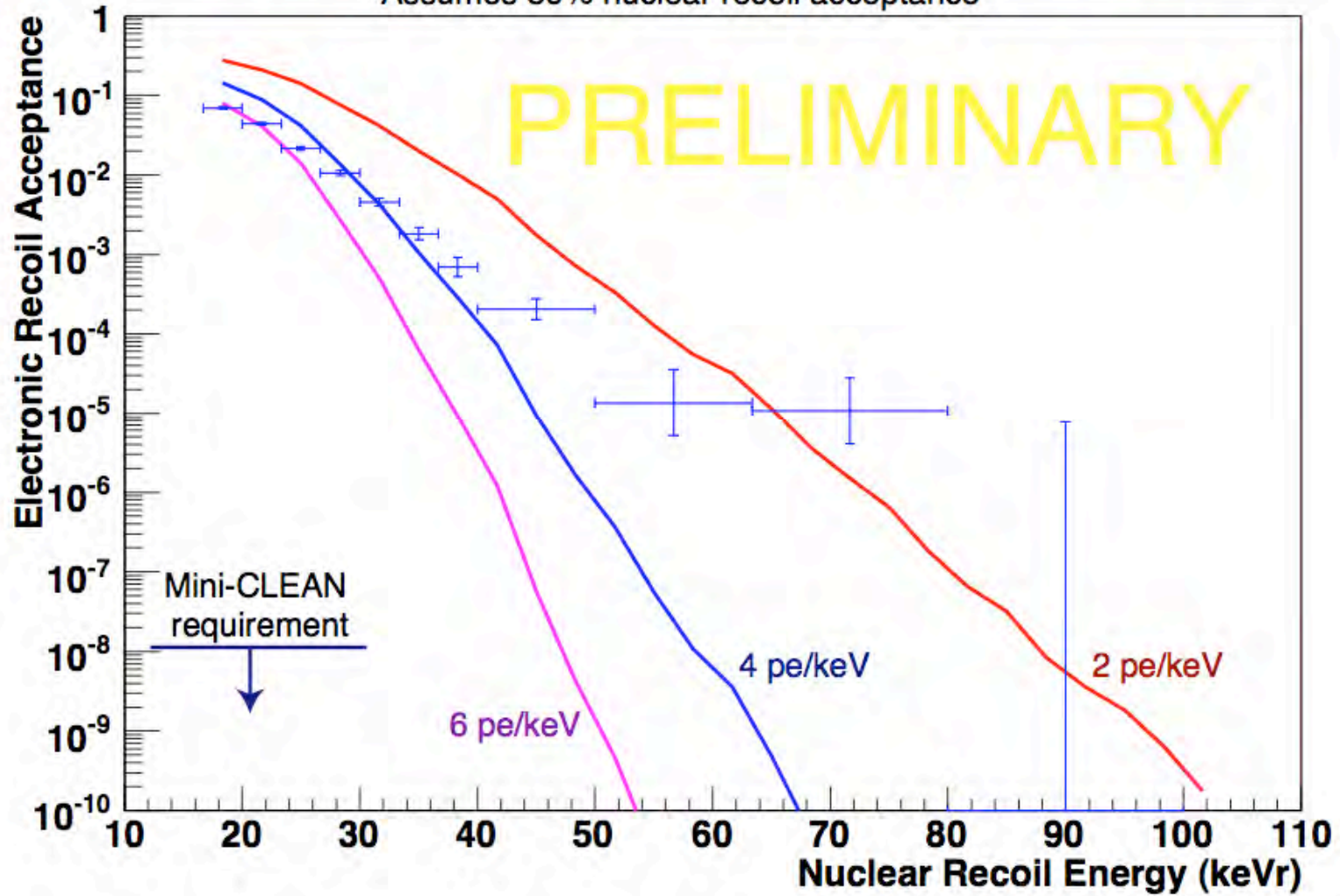

miniCLEAN (proposed)

- 100 kg miniCLEAN
 - WIMP Goal $\sim 5 \times 10^{-45} \text{ cm}^2$
 - 10 events/year
- Backgrounds
 - PMT Gammas
 - Requires better than 10^{-8} rejection of ER at 50 keVr
 - Currently demonstrated 10^{-5} >50 keVr (limited by neutron bg in lab)
 - PMT neutrons
 - Studies on going, but these are expected to be limitation to sensitivity of smaller instrument
 - Less of problem in larger target
 - Position Reconstruction
 - How well can events leaking from outer

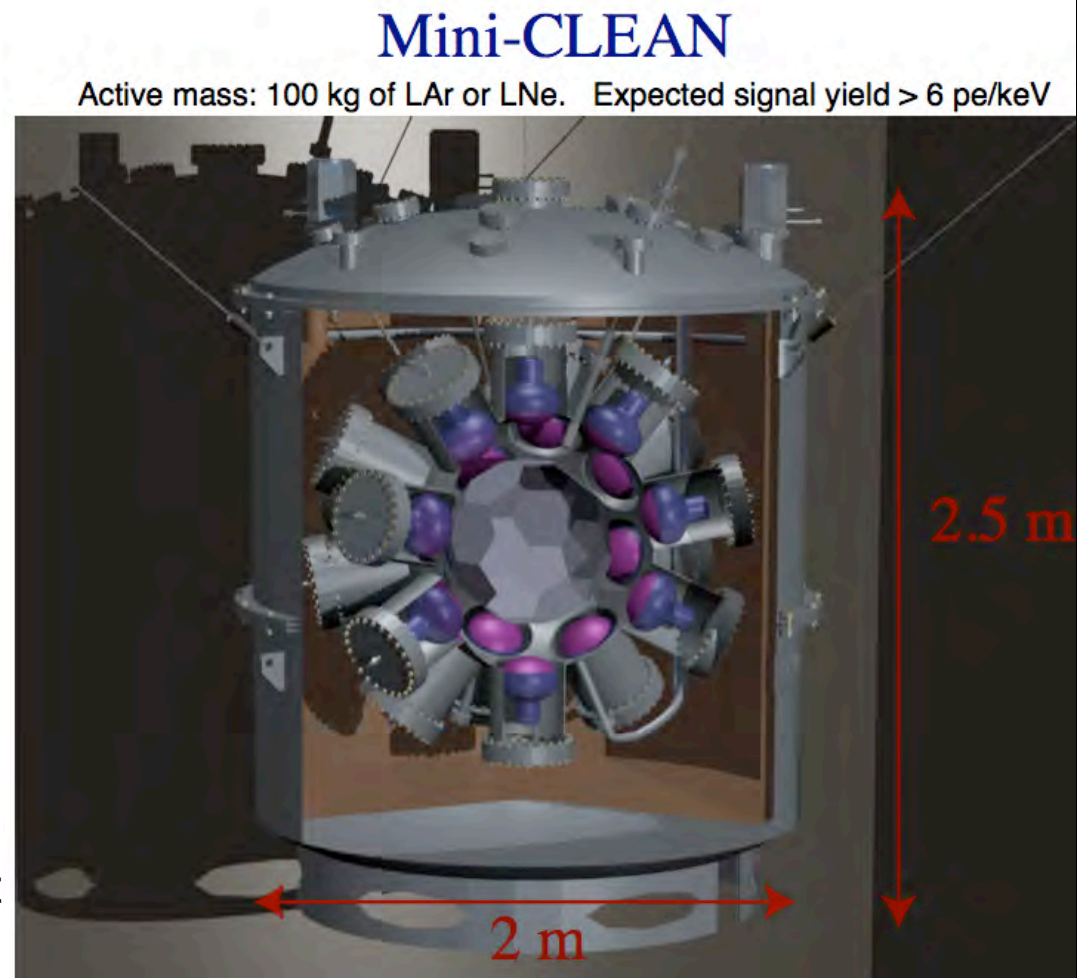

DEAP-1 (being deployed)

- DEAP-1 (Boulay / Hime)
 - Also based on scintillation PSD alone
 - Queen's (Boulay) leading effort - Canadian Groups + Yale/LANL
 - 7 kg LAr with 2x PMT
 - Have been studying PSD using tagged ^{22}Na source to limit lab neutron contamination
 - Preliminary data showing $\sim 10^{-4}$ - 10^{-5} discrimination. Will continue to push stats.
 - Detector will be taken underground at SNOLab shortly
 - Poor position reconstruction and so likely to be limited by surface events

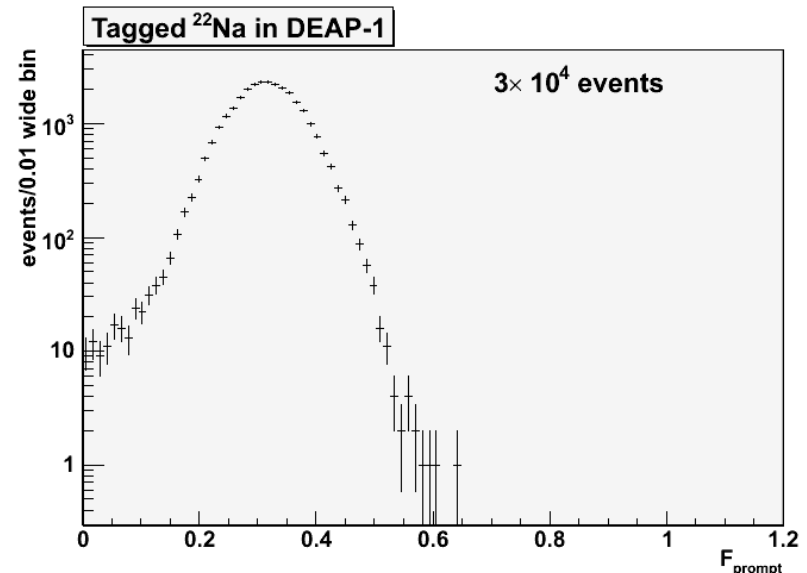
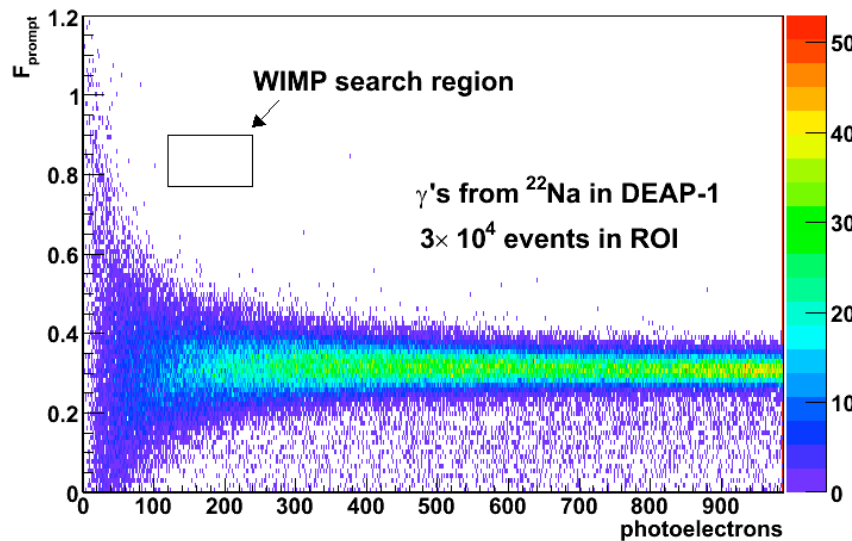

DEAP-1 design

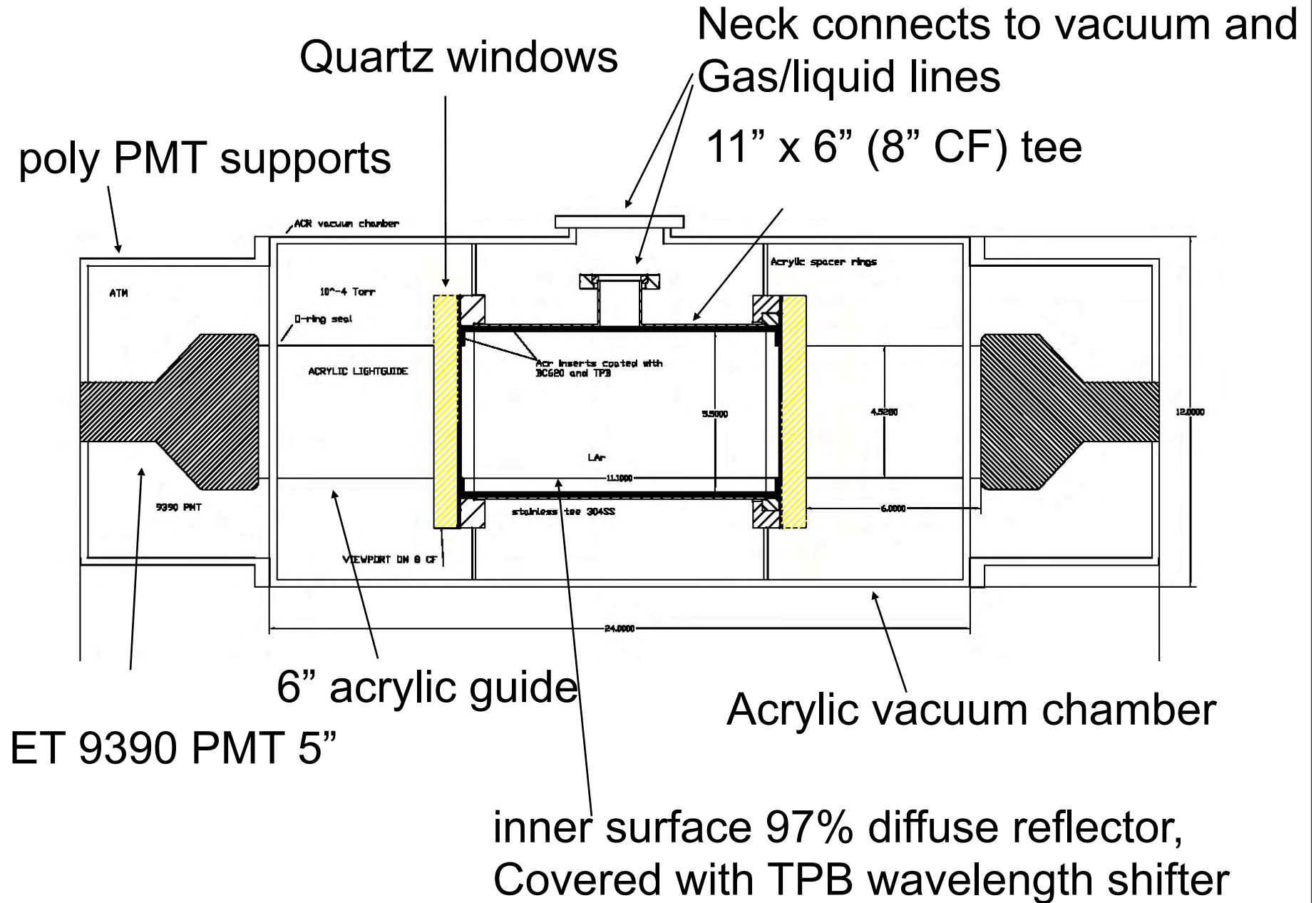

DEAP & CLEAN “ULTIMATE” designs

“miniCLEAN” 1000 kg

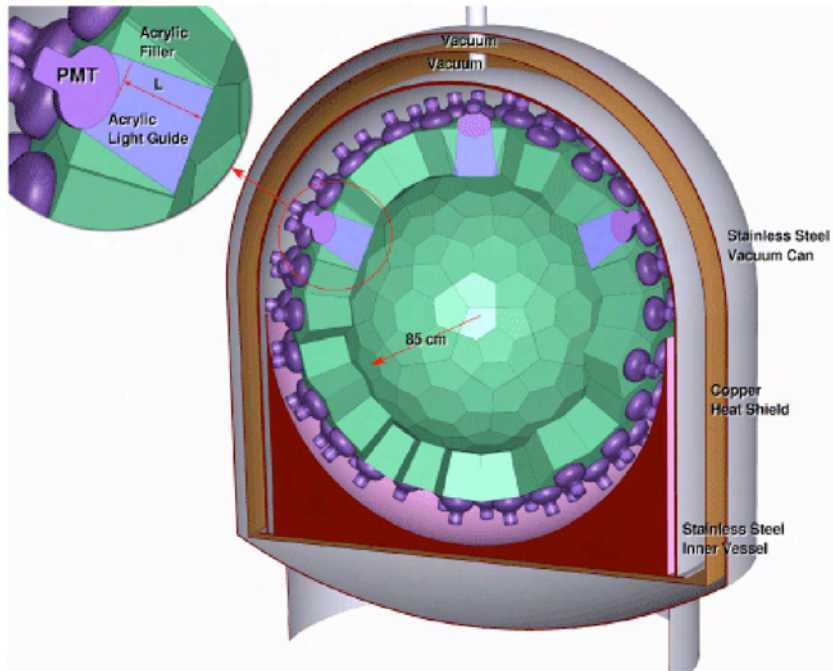

DEAP-3

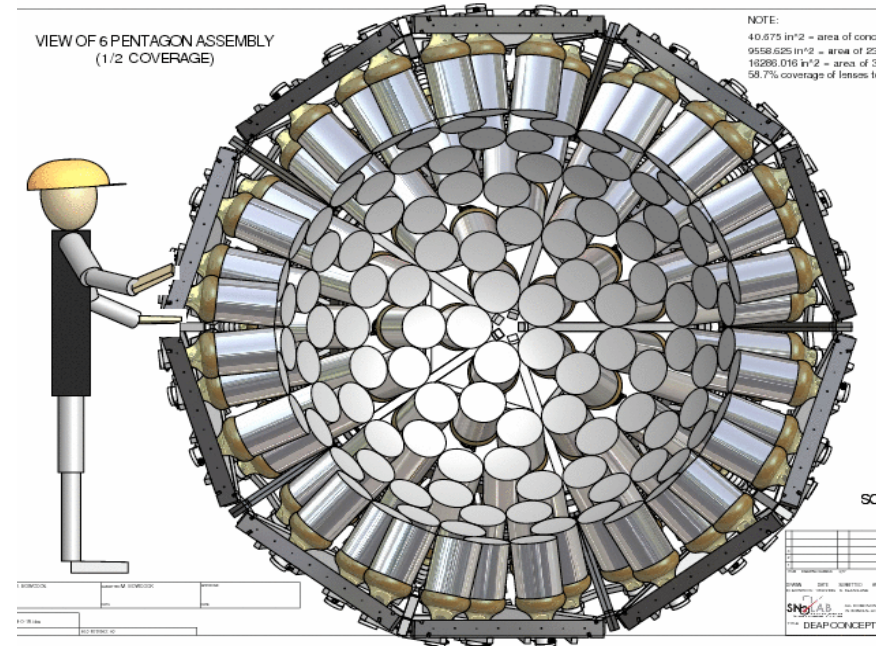

- Design is driven by need for neutron reduction via hydrogenous material
- Vacuum thermal insulation versus ice thermal insulation
- Ice insulation not the preferred design for neon due to heat loads
- Liquid Argon 87 K (greater than LN2), Liquid Neon (27 K)

XMASS 100 kg (Xe) - Japan

- XMASS

- 100 kg Prototype operated
 - Limited PMT coverage / Position reconstruction of events near walls at center
- Next step is to 800 kg

➤ Status of 800 kg detector

- Basic performances have been already confirmed using prototype detector

- ✓ Method to reconstruct the vertex and energy
- ✓ Self shielding power
- ✓ BG level



- Detector design is going using MC

- ✓ Structure and PMT arrangement (812 PMTs)
- ✓ Event reconstruction
- ✓ BG estimation

- New excavation will be done soon

XMASS 800 kg - Japan

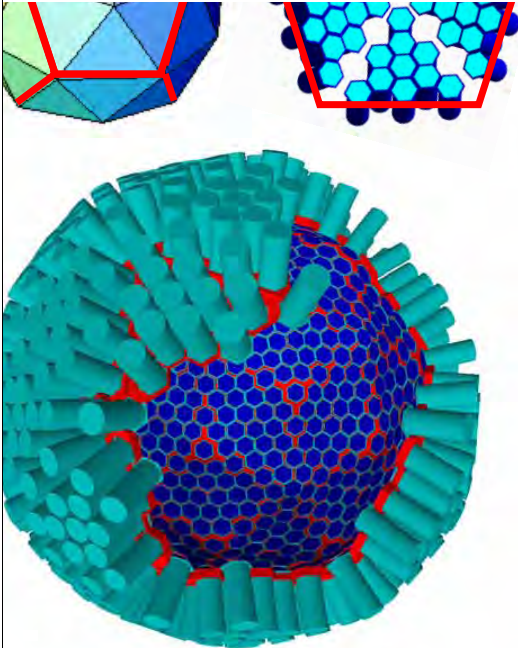

- 60 triangles
- 10 PMT/triangle x 60 = 600 PMTs
- + 212 PMTs in triangle boundary region
- **Total 812 PMTs**
- **Photo coverage 67.0%**
- Center to photocathode ~45cm
- Fiducial volume is 25cm from center.
- PMTs are inside liquid xenon.

Decision on funding of 800 kg phase currently be considered

Summary

- XMASS 800kg detector
 - 1 ton liquid xenon, 90cm diameter, 60 triangles, 812 PMTs
 - BG level 10^{-4} $\text{dru}(\text{day}^{-1}\text{kg}^{-1}\text{keV}^{-1})$
 - Dark matter search 10^{-45} cm^2
- Detector design by simulation
 - Resolution of event reconstruction
 - 10keV ~3cm 5keV ~5cm at boundary of fiducial volume
 - Background from PMT
 - ^{238}U , ^{60}Co $\sim 10^{-5}$ dru inside fiducial volume
 - Water shield for ambient γ and fast neutron
 - 200cm shield is enough

Background from PMT ^{238}U

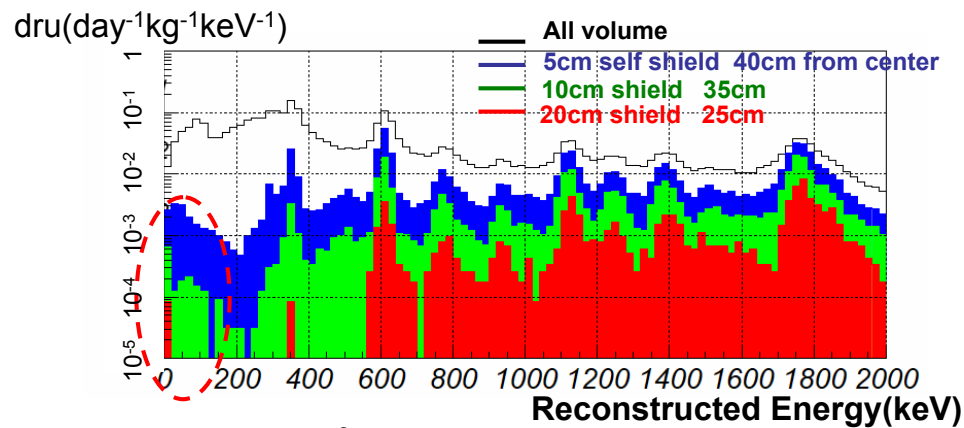

- $1.8 \times 10^{-3} \text{ Bq/PMT}$

XENON Event Discrimination: Electron or Nuclear Recoil?

Within the **xenon** target:

- **Neutrons, WIMPs** => Slow nuclear recoils => strong columnar recombination

=> **Primary Scintillation (S1) preserved, but Ionization (S2) strongly suppressed**

- γ , e^- , μ , (etc) => Fast electron recoils =>

=> **Weaker S1, Stronger S2**

Ionization signal from nuclear recoil too small to be directly detected => **extract charges from liquid to gas** and detect much larger proportional scintillation signal => **dual phase**

Simultaneously detect (array of UV PMTs) primary (S1) and proportional (S2) light =>

Distinctly different S2 / S1 ratio for e / n recoils provide basis for event-by-event discrimination.

Challenge: ultra pure liquid and high drift field to preserve small electron signal (**~ 20 electrons**); efficient extraction into gas; efficient detection of small primary light signal

(**~ 200 photons**) associated with **16 keVr**

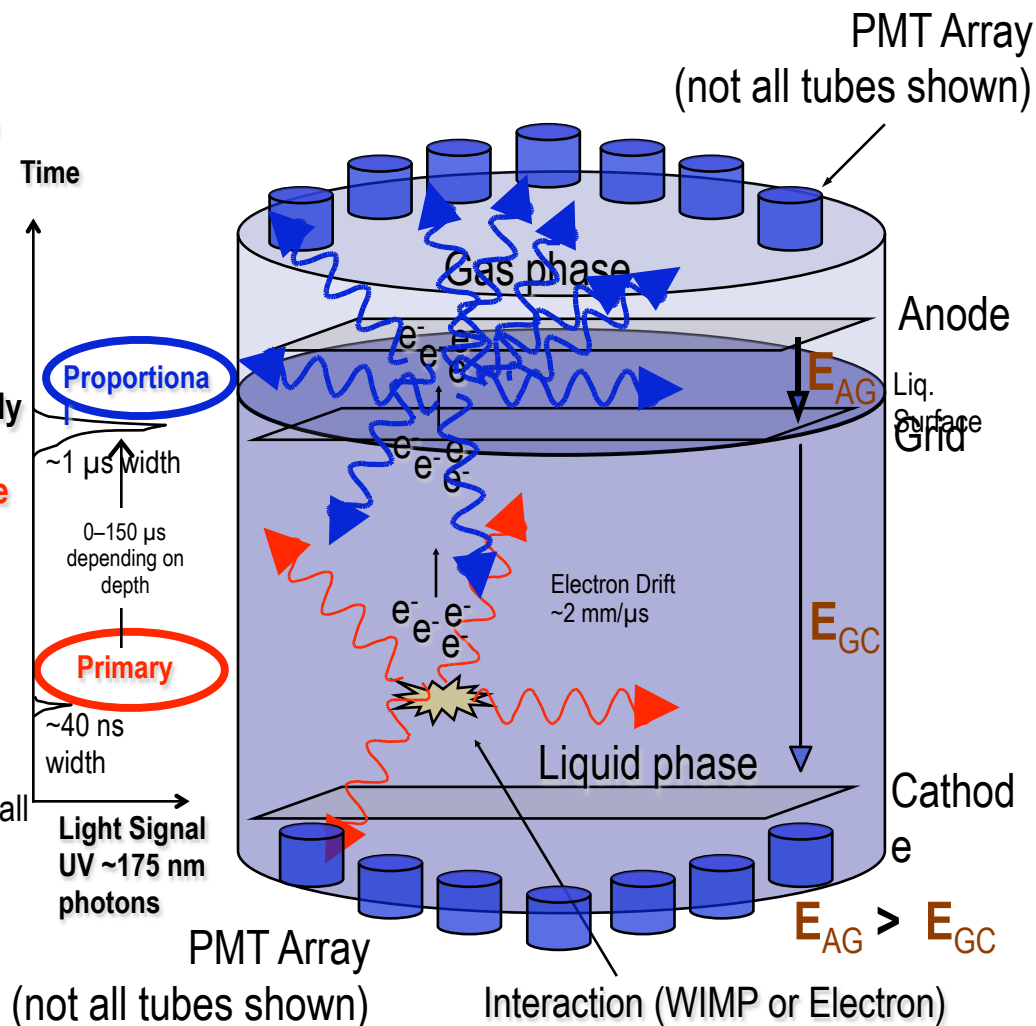

Two-phase Argon Detectors: WARP and ArDM

- PSD and secondary scintillation from ionization drift
- WARP (Carlo Rubbia)
 - u 3.2 kg prototype running at Gran Sasso
 - u Preliminary results reported
 - u 140-kg detector w/800-kg active veto under construction
- ArDM (Andre Rubbia)
 - u LEMs for ionization readout
 - u PMTs for primary scintillation
 - u 1 ton prototype in construction

WARP Prototype

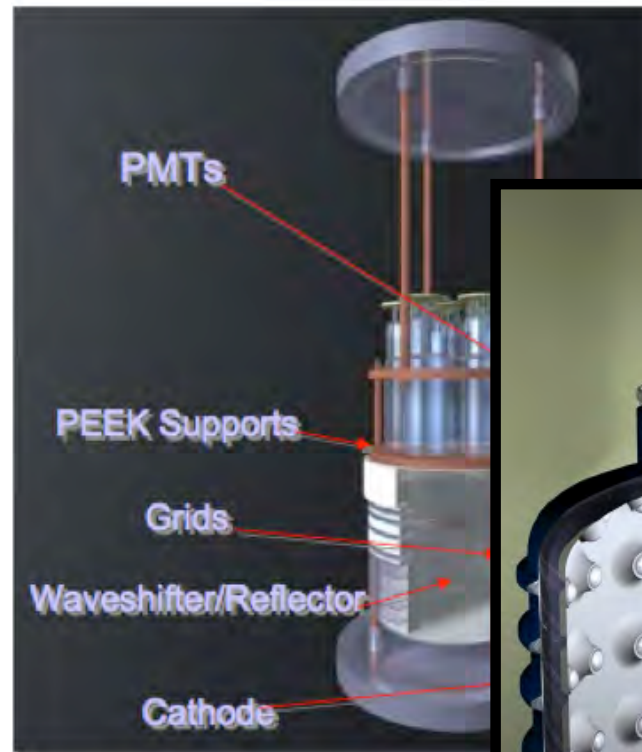

WARP



Schematic view of the 2.3 chamber
100-I detector

WARP - Dual Methods of Discrimination

- PSD
 - Nuclear Recoil “Ion” has larger prompt component as in single phase
- S2/S1
 - Also have Ionization/Scintillation

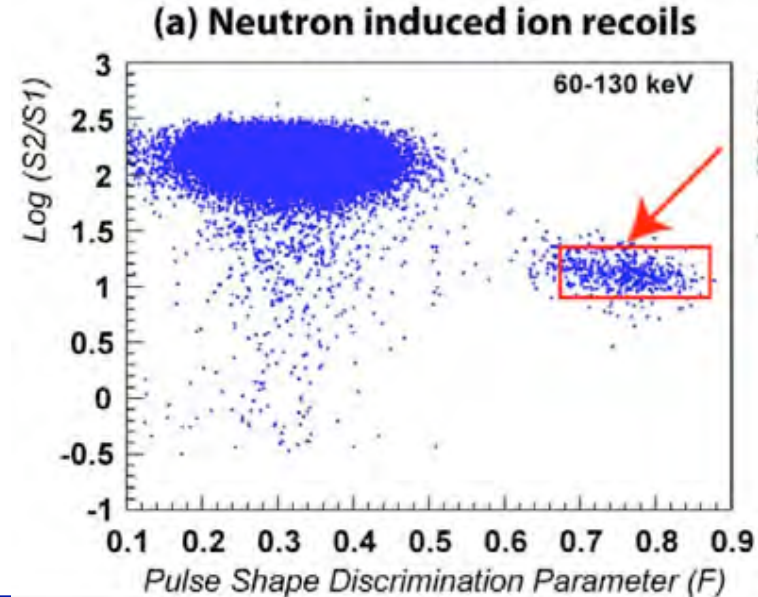
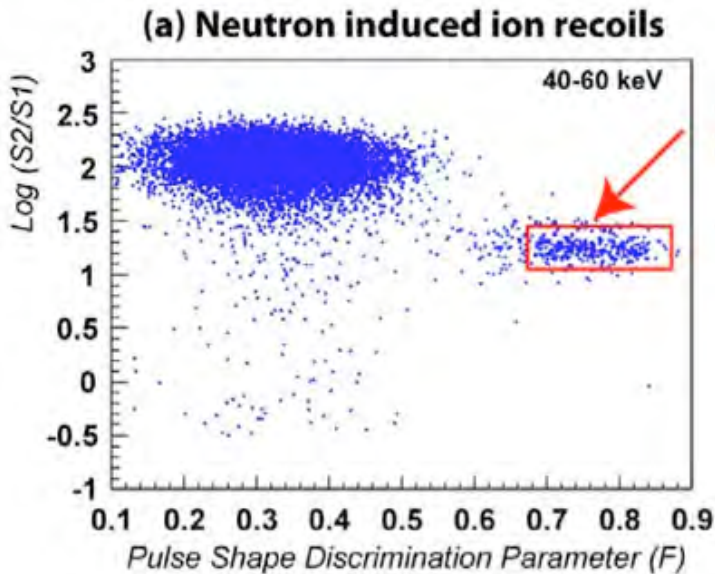
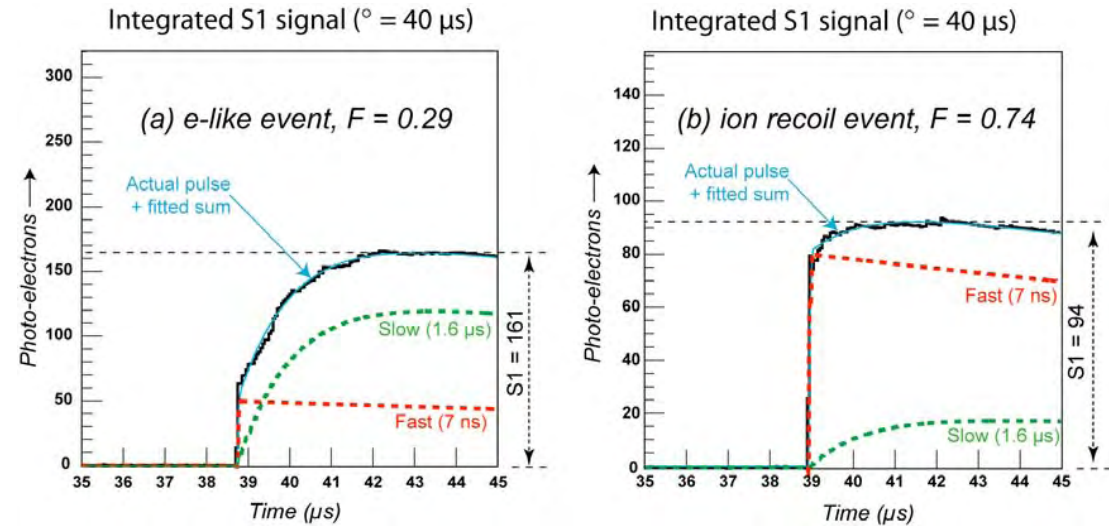

WARP Recent Results (Jan 07) astro-ph/0701286

- Analysis with no events above 55 keV (energy threshold selected a posteriori) yields limit at cyan line (5x above CDMS).
 - ◻ At this threshold energy Ar is 1/10 as sensitive to WIMPs per unit mass as Ge $E > 10$ keV
 - ◻ The 40 keVr cyan dashed line is a simple “what if” there were no events above 40 keVr
- Have new data run of ~50 kg-days with improved electronics - suggest that it will remove some/all of low energy events. (Announce soon)

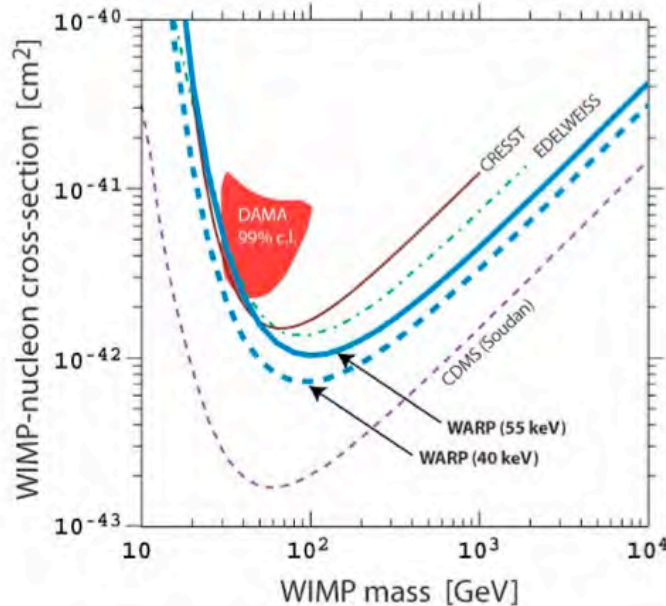

Noble Liquids

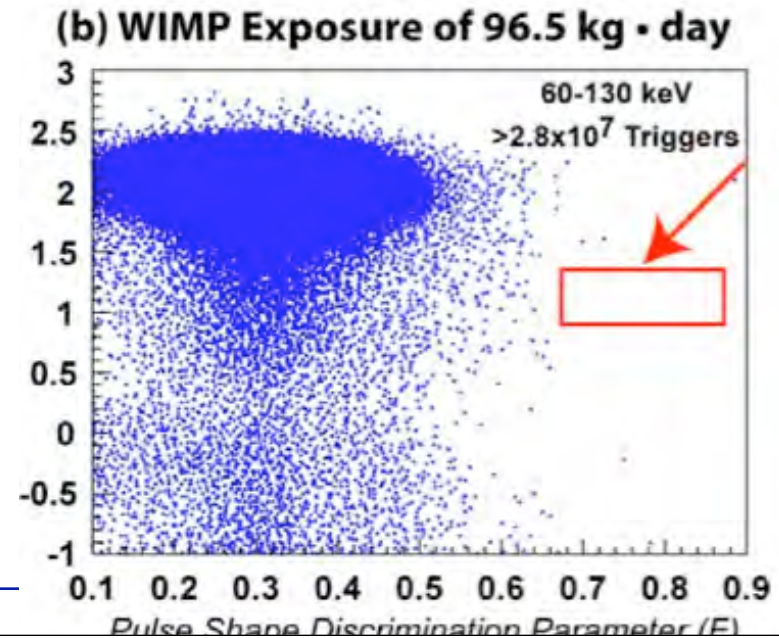
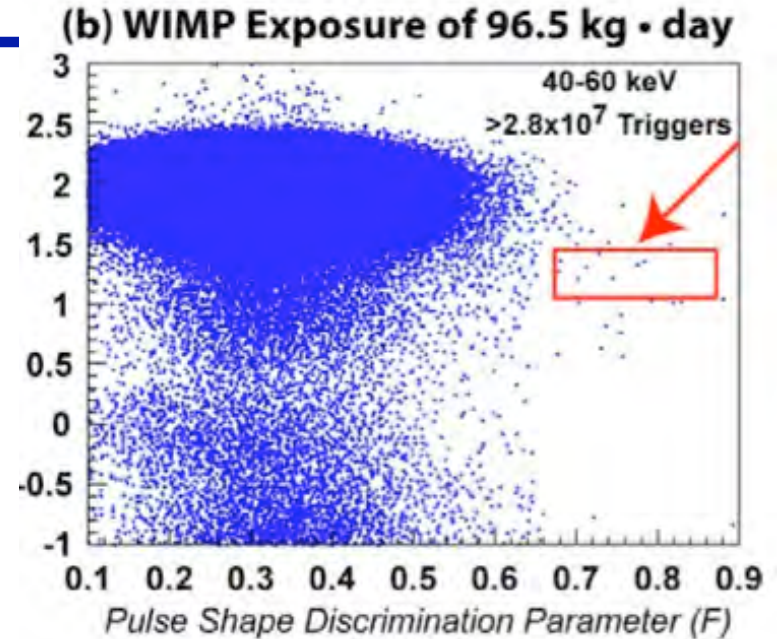

39Ar Beta Background - Event Rejection vs Removal

- Note that regular Ar contains 39Ar ~ 1 Bq/kg, which gives beta spectrum (end point ~ 500 keV) with a low energy tail of ~ 150 evts/keVee/kg/day
- This means that in order to match current best CDMS II sensitivity an Ar experiment must deliver at least $\sim 10^6$ rejection.
 - Fiducialization/multiple scatter cuts don't help in reducing this rate
- Possible ways of dealing with it
 - Improve discrimination so it become irrelevant (although still have to deal with the event rate 1 kHz in 1 tonne)
 - Isotopic reduction (WARP have taken delivery of 3 liters of Ar with $\sim 1/50$ activity for running in WARP prototype)
 - Extraction of Ar from underground wells
 - However, underground (n,p) process in 39K will generate 39Ar. ($n > 3$ MeV are generated by U/Th decays)
 - An initial sample that was tested from an underground well had 50x (larger) than usual 39Ar:Ar concentration - large survey will be required to understand factors effecting levels.

ZEPLIN-II Detector

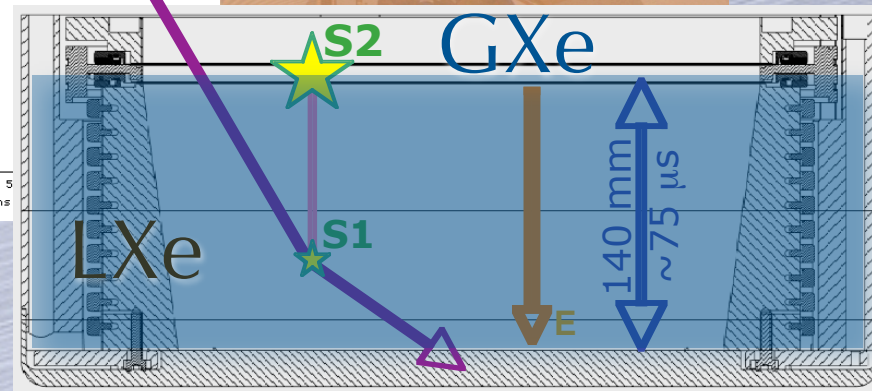
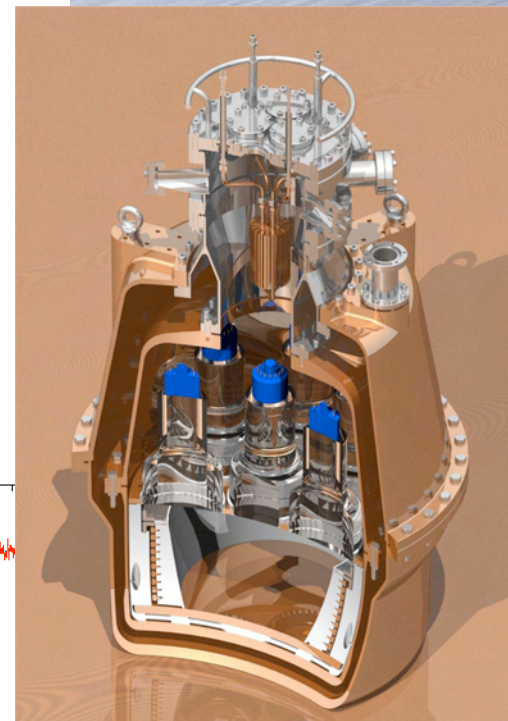
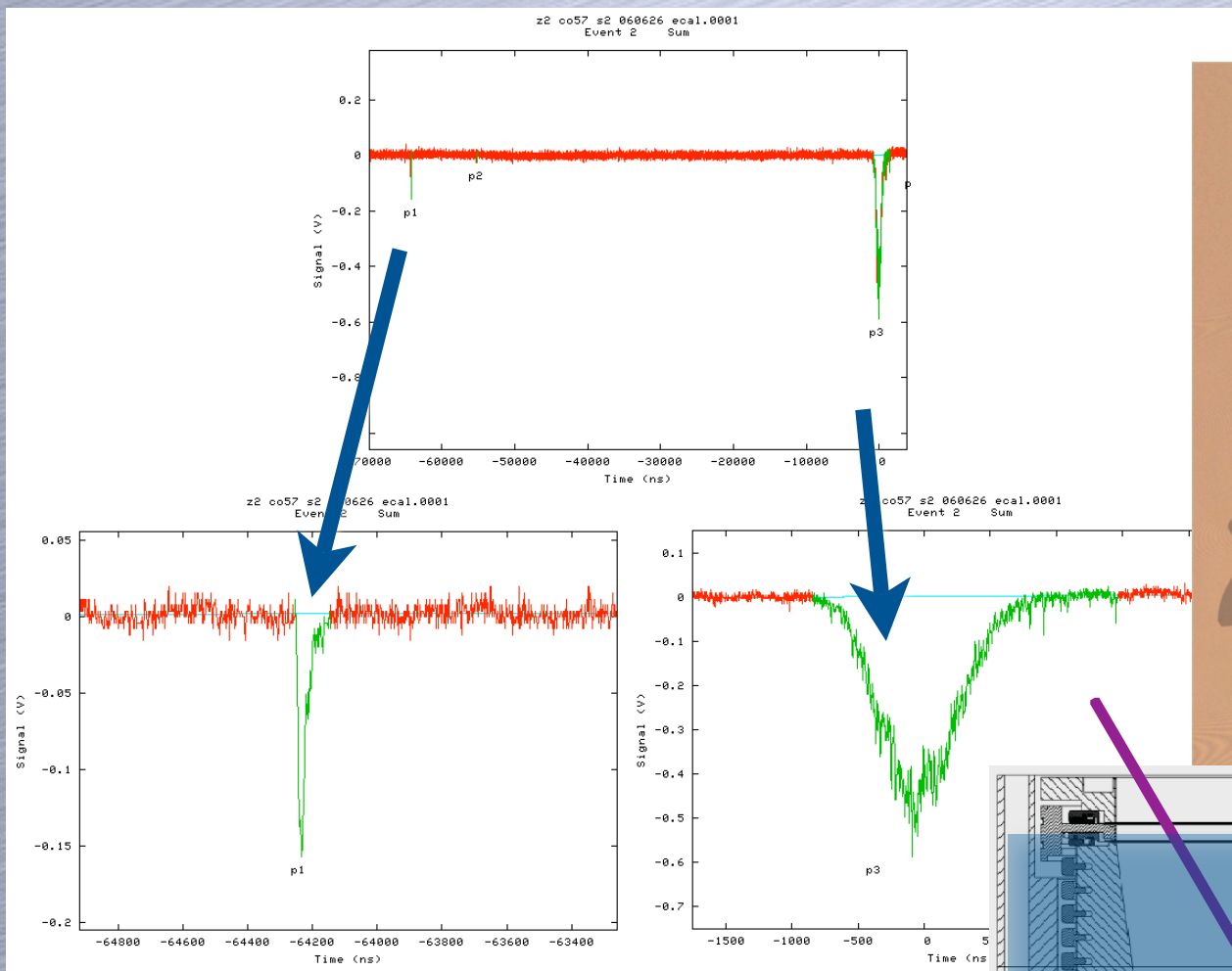

- 5 months continuous operation
- 1.0t*day of raw DM data

Discrimination Power

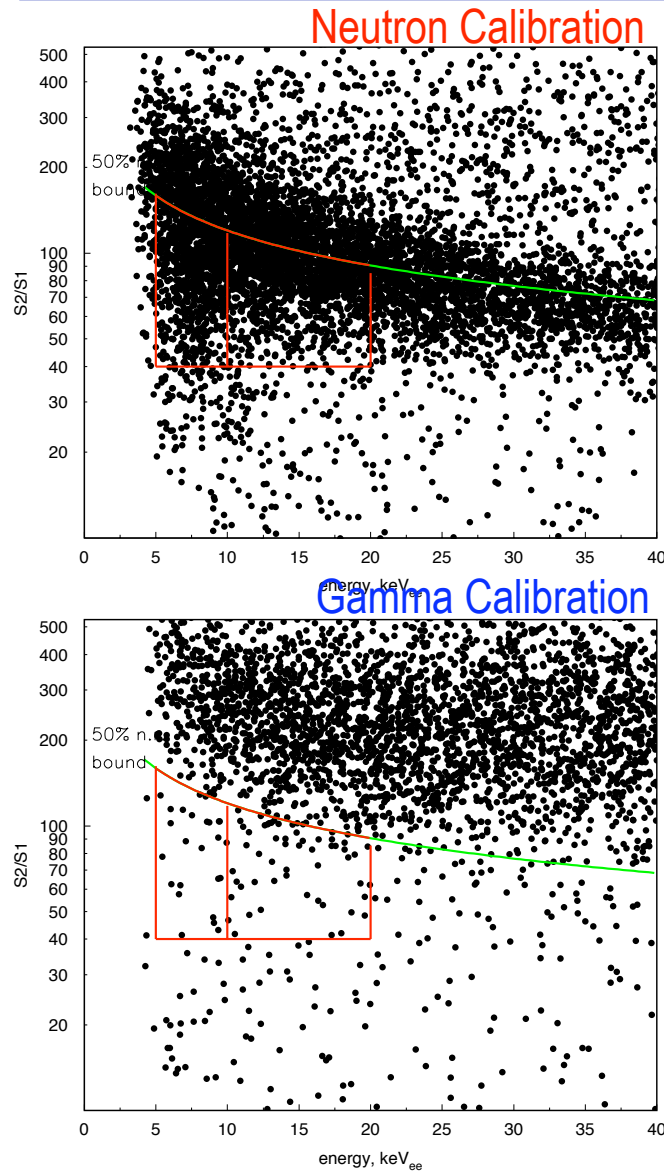

- AmBe calibration (upper)
- Co-60 Calibration (lower)
 - Used to define acceptance window
 - 50% n.r. acceptance shown
 - lower $S2/S1=40$ bound fixed
 - Box defined 5-20keVee
- Uniform population across plots
 - high rate calibrations (esp Co-60)
 - coincidences between events and 'dead-region' events
- 98.5% γ discrimination at 50% n.r. acceptance

ZEPLIN II

- 31 live days running, 225 kg-days exposure
 - Red Box is 5-20keVee, 50% NR acceptance based on neutron calibration
 - 29 candidate events seen
 - Estimate 50% from ER leakage from upper band
 - Other 50% from lower band which are RAdon daughters plating on PTFE side walls
 - Both populations have been modeled and subtraction performed
 - Final results is <10.4 events (90% CL) consistent with WIMP

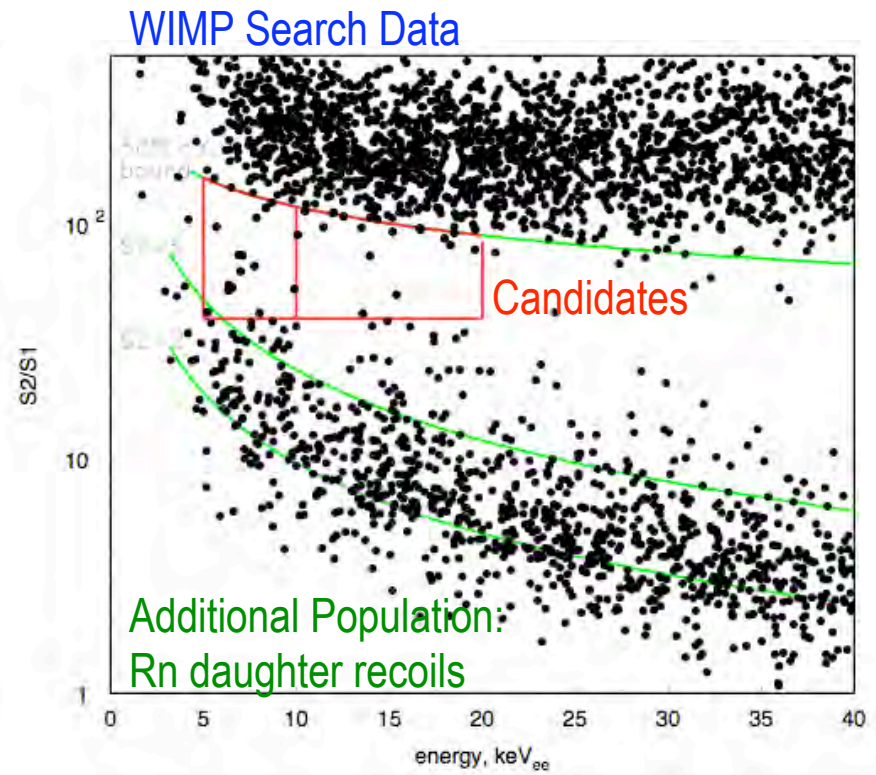

The XENON10 Detector

- 22 kg of liquid xenon
 - 15 kg active volume
 - 20 cm diameter, 15 cm drift
- Hamamatsu R8520 1"×3.5 cm PMTs
 - bialkali-photocathode Rb-Cs-Sb,
 - Quartz window; ok at -100°C and 5 bar
 - Quantum efficiency > 20% @ 178 nm
- 48 PMTs top, 41 PMTs bottom array
 - x-y position from PMT hit pattern; $\sigma_{x-y} \approx 1$ mm
 - z-position from Δt_{drift} ($v_{d,e} \approx 2$ mm/ μ s), $\sigma_Z \approx 0.3$ mm
- Cooling: Pulse Tube Refrigerator (PTR),
- 90W, coupled via cold finger (LN2 for emergency)

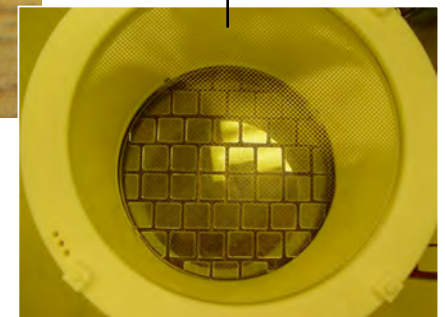
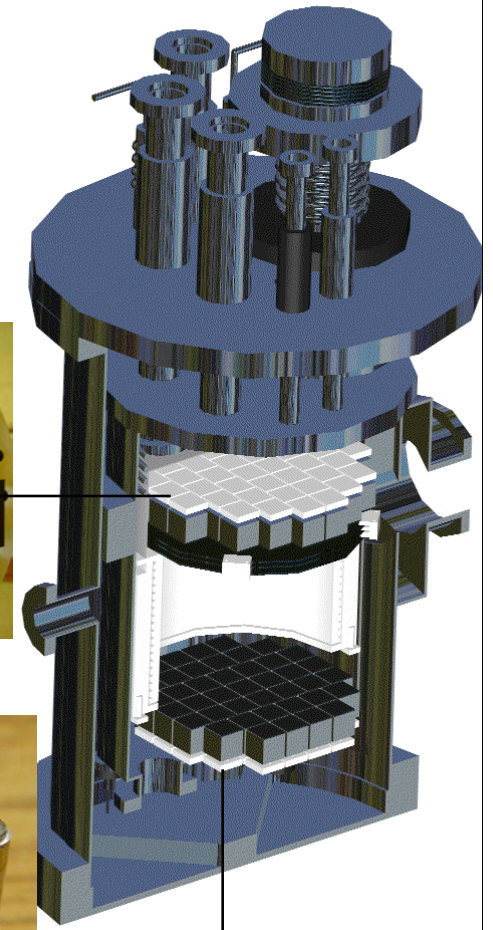
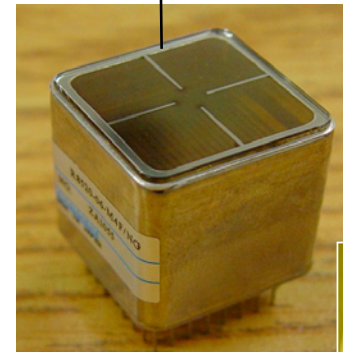
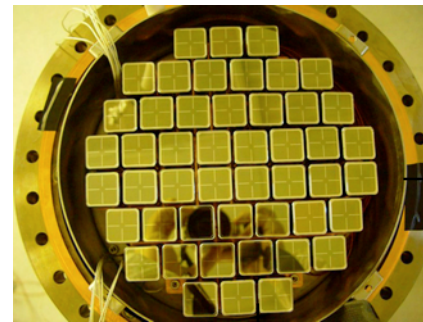

The XENON10 Collaboration

Columbia University **Elena Aprile**, Karl-Ludwig Giboni, Maria Elena Monzani, **Guillaume Plante**, **Roberto Santorelli** and Masaki Yamashita

Brown University **Richard Gaitskell**, Simon Fiorucci, Peter Sorensen and **Luiz DeViveiros**

RWTH Aachen University Laura Baudis, **Jesse Angle**, Joerg Orboeck, **Aaron Manalaysay** and Stephan Schulte

Lawrence Livermore National Laboratory Adam Bernstein, Chris Hagmann, Norm Madden and Celeste Winant

Case Western Reserve University Tom Shutt, Peter Brusov, **Eric Dahl**, John Kwong and Alexander Bolozdynya

Rice University Uwe Oberlack, **Roman Gomez**, Christopher Olsen and Peter Shagin

Yale University Daniel McKinsey, Louis Kastens, **Angel Manzur** and **Kaixuan Ni**

LNGS Francesco Arneodo and Alfredo Ferella

Coimbra University Jose Matias Lopes, Luis Coelho, Luis Fernandes and Joaquin Santos



XENON10: Ready for Low Background Operation

Installation of the Detector...

...and we are operational



XENON10 Live time at Gran Sasso

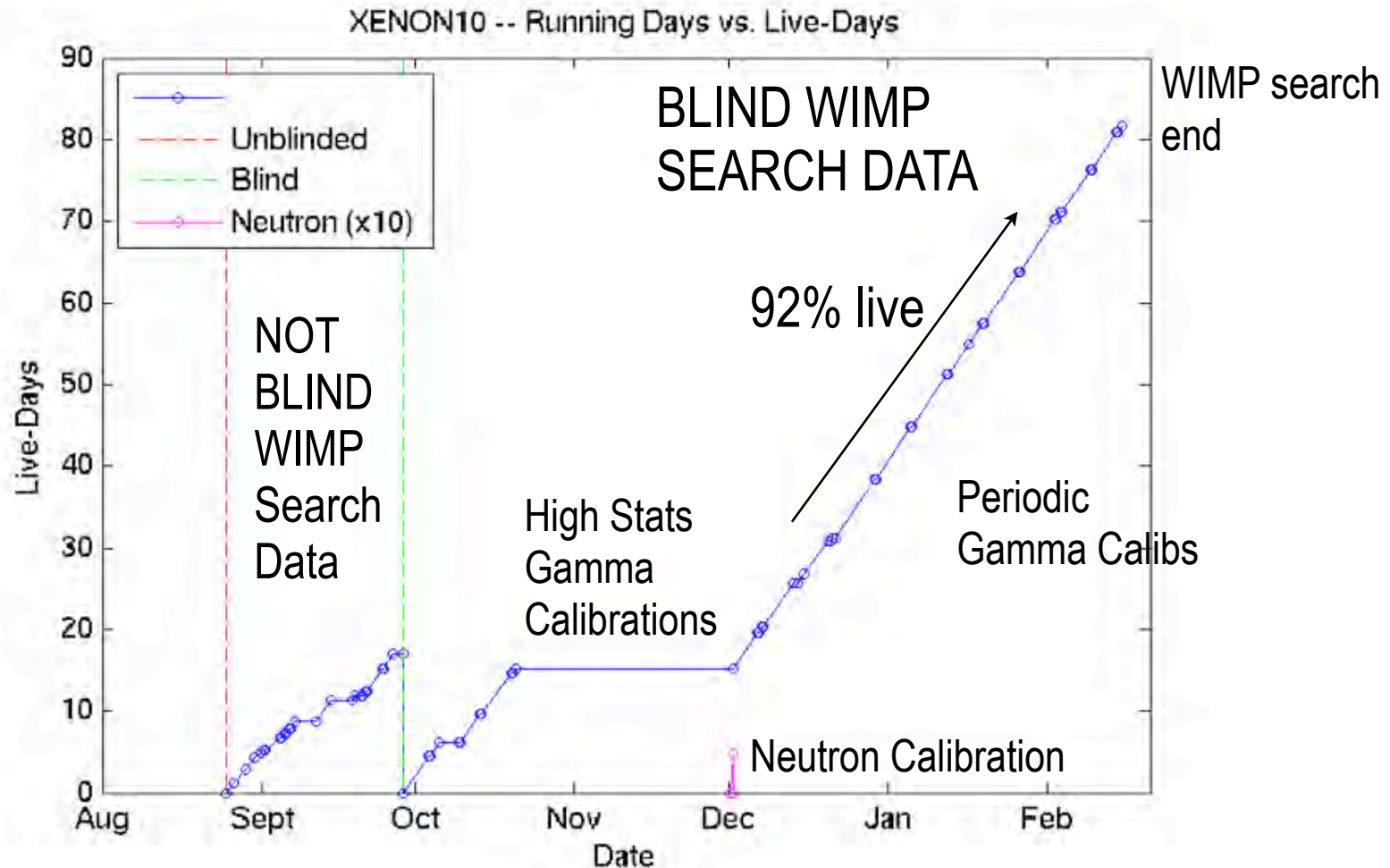

- Discuss data from High Statistics Gamma Calib, Neutron Calib and NON BLIND WIMP search data ~20 live days
- WIMP Search results (from 80 live day) will be announced at April APS Meeting

XENON10 Detector

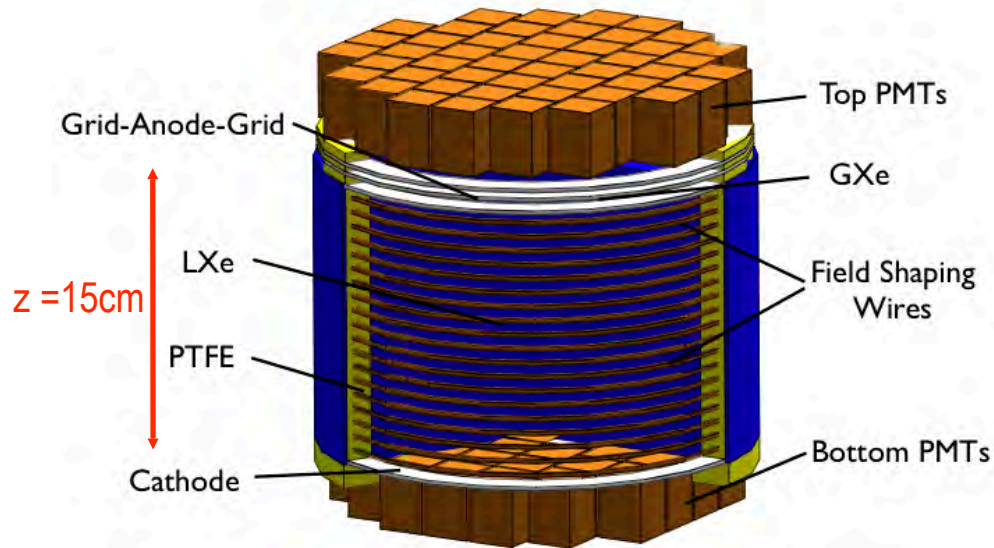

89 PMTs: Hamamatsu R8520-AL 2.5 cm square

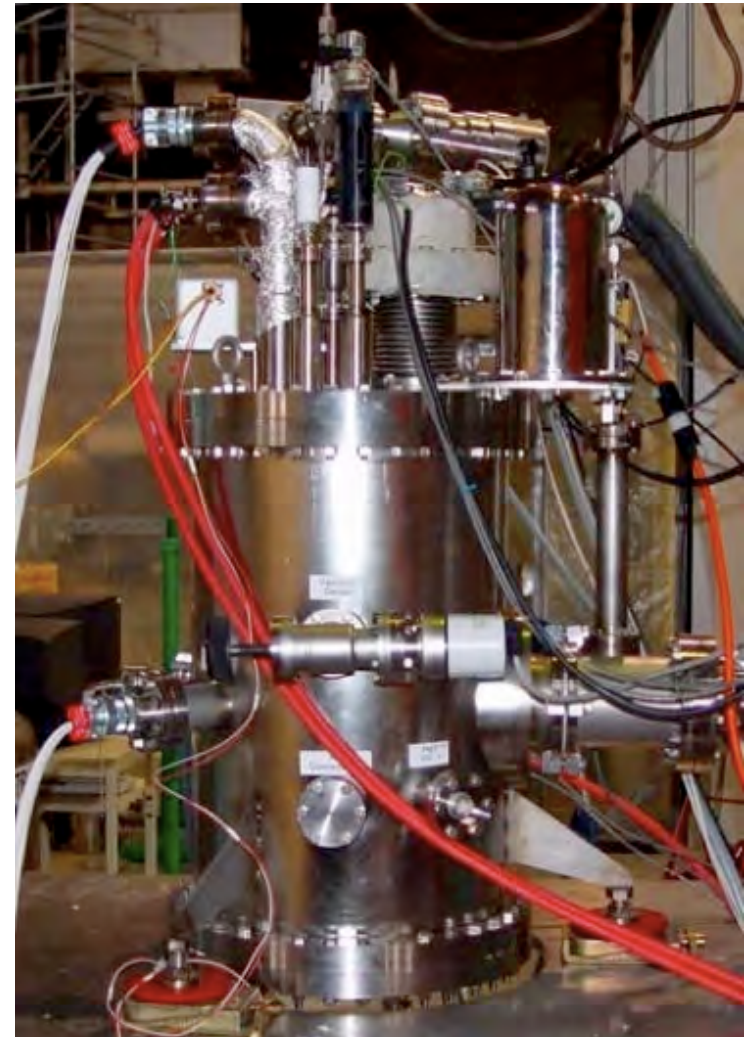
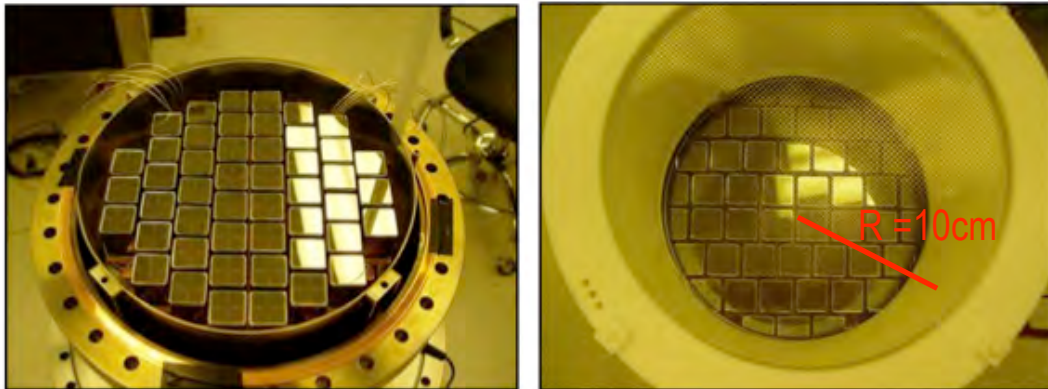

XENON10 Event Discrimination

Example: Low Energy Compton Scatter

- S1=15.4 phe ~ 6 keVee
- Drift Time ~38 μ s => 76 mm

s1: Primary Scintillation Created by Interaction LXe

s2: Secondary Scintillation Created by e- extracted & accelerated in GXe

$$(s2/s1)_{ER} > (s2/s1)_{NR}$$

Expect > 99% rejection efficiency of γ/n Recoils...

Reduction of Backgrounds =>
Reduction of Leakage Events

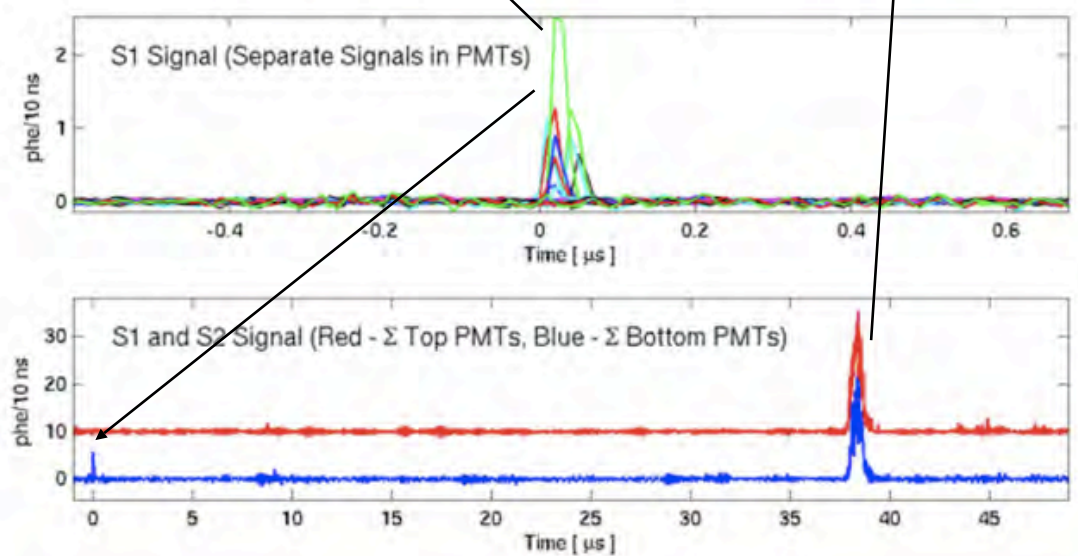
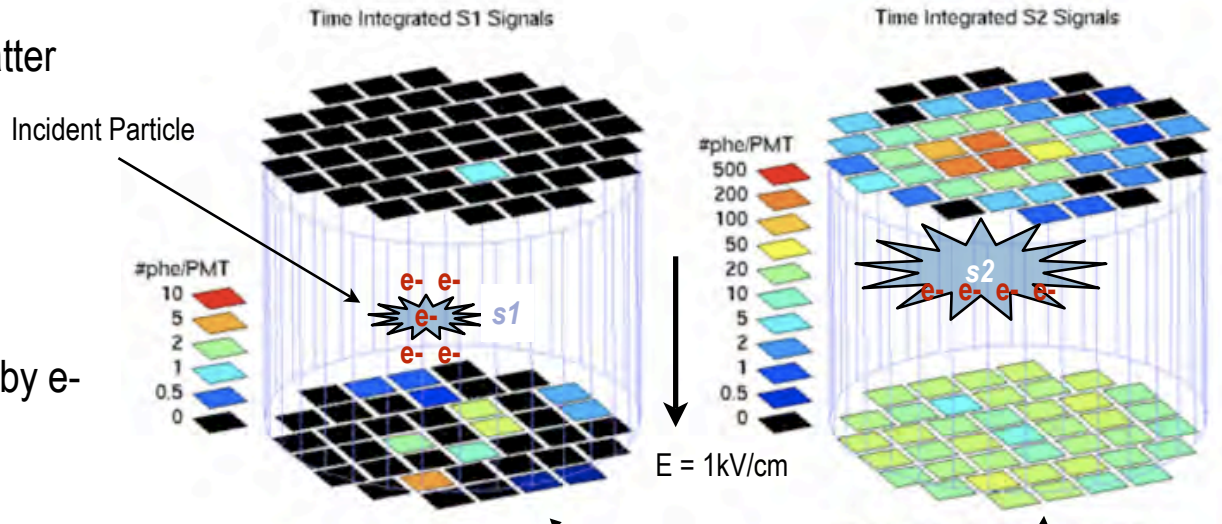

Gamma Calibration (Electron Recoils == Background)

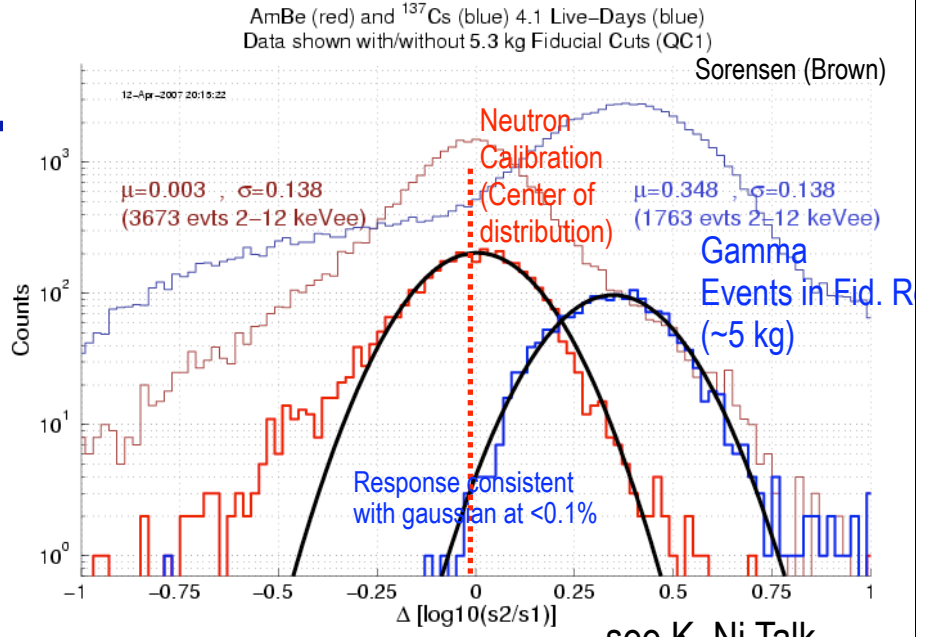
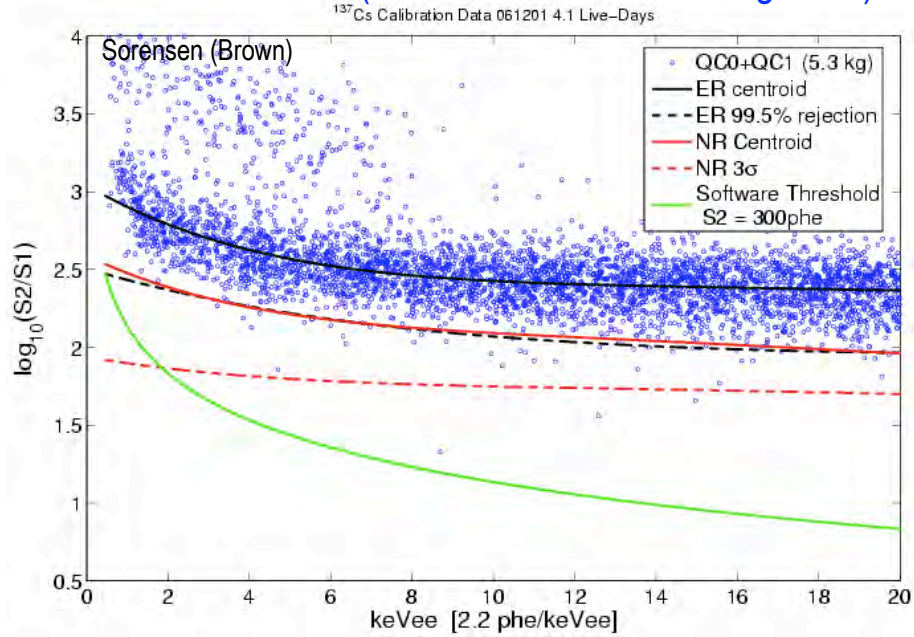

see K. Ni Talk

Neutron Calibration

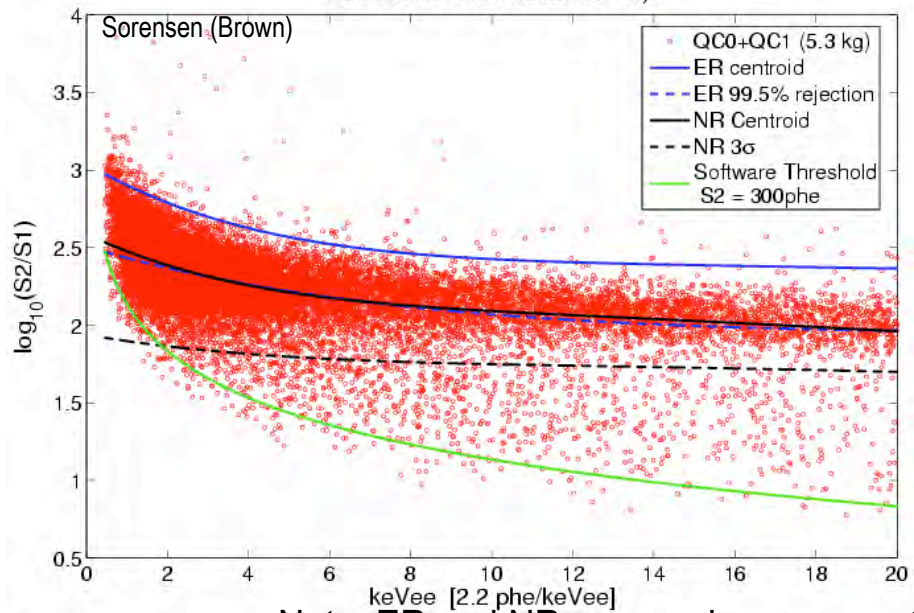

single nuclear recoils ~20% discrep

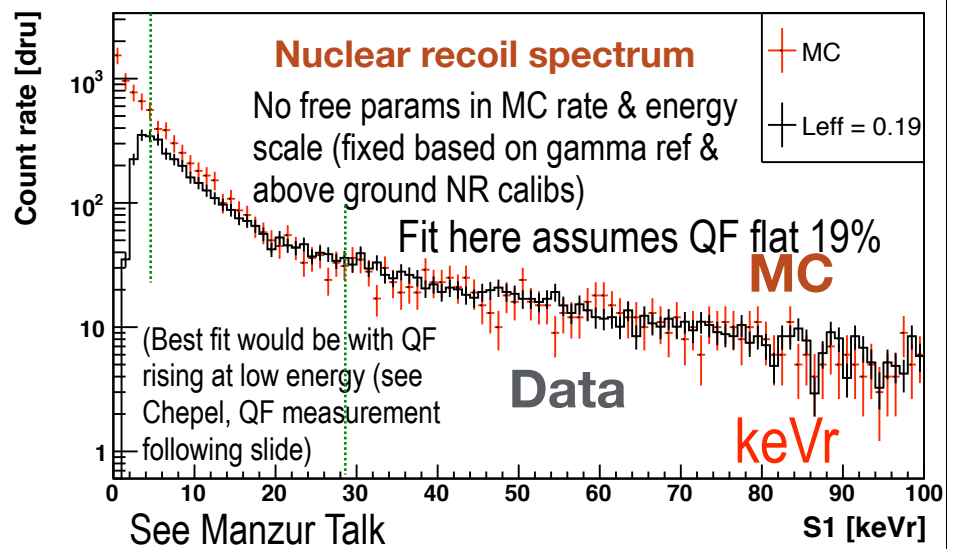

See Manzur Talk

Note: ER and NR curves shown are not final versions used in 58 day WIMP Blind analysis

Applying the Gamma-X Cuts to XENON10 Data

See Aprile / Manalaysay

Talk

§ XENON10 Blind Analysis – 58.6 days

§ WIMP “Box” defined at

- ~50% acceptance of Nuclear Recoils (blue lines): [Centroid -3σ]
- 2-12keVee (2.2phe/keVee scale)
- Assuming QF 19% 4.5-27 keVr

§ 10 events in the “box” after all primary analysis blind cuts (o)

§ 5 of events are consistent with gaussian tail from ER band

- Fits based on ER calibrations projected $7.0 +2.1-1.0$ events

§ 5 of these are *not consistent* with Gaussian distribution of ER Background

$\log (S2 / S1)$ vs S1
“Straightened Y Scale” – ER Band Centroid $\Rightarrow 2.5$

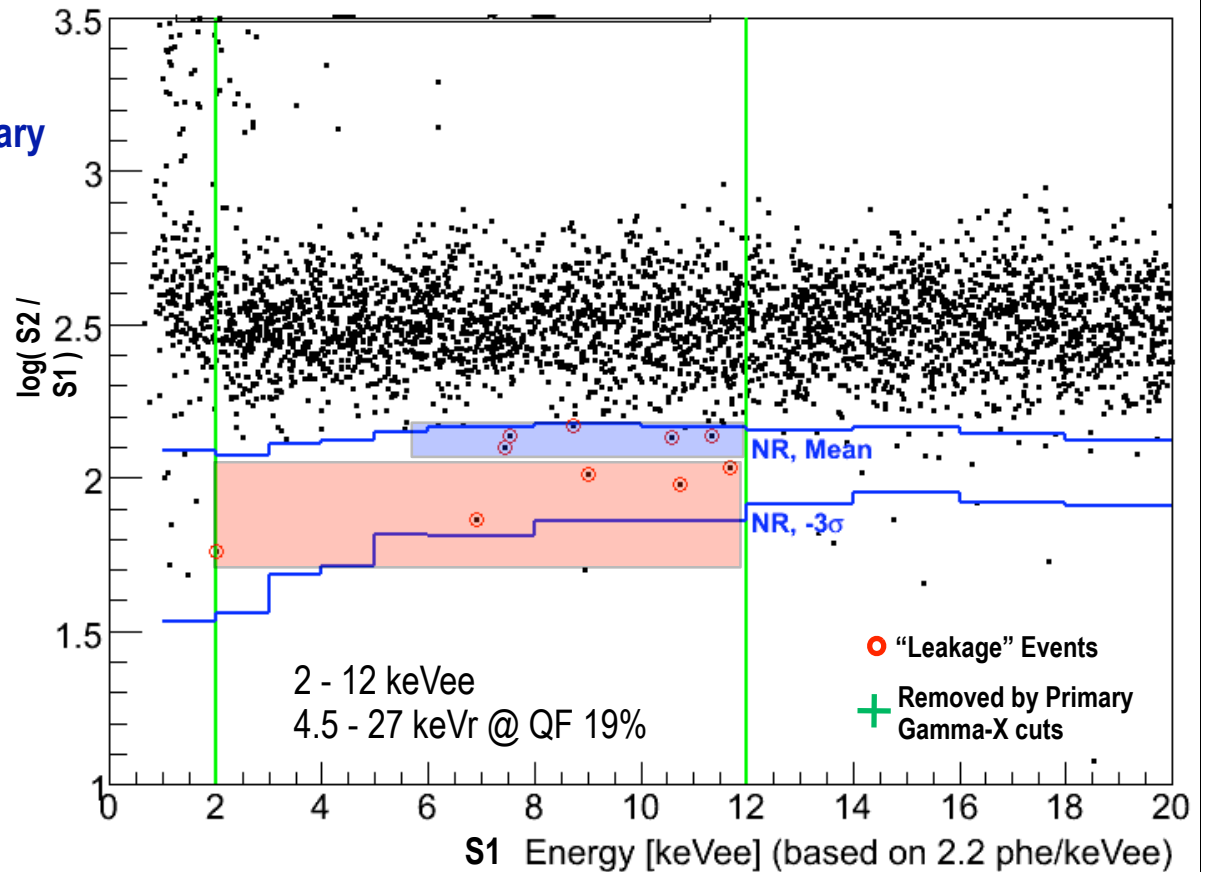

Applying the Gamma-X Cuts to XENON10 Data

§ XENON10 Blind Analysis – 58.6 days

§ WIMP “Box” defined at

- ~50% acceptance of Nuclear Recoils (blue lines): [Centroid -3σ]
- 2-12keVee (2.2phe/keVee scale)
- Assuming QF 19% 4.5-27 keVr

§ 10 events in the “box” after all primary analysis blind cuts (o)

§ 5 of events are consistent with gaussian tail from ER band

- Fits based on ER calibrations projected $7.0 +2.1-1.0$ events

§ 5 of these are *not consistent* with Gaussian distribution of ER Background

- 4 out of 5 events removed by Secondary Blind Analysis (looking for missing S2/Gamma-X events)
- Remaining event would have been caught with 1% change in cut acceptance : **WIMP SIGNAL UNLIKELY**

log (S2 / S1) vs S1
 “Straightened Y Scale” – ER Band Centroid => 2.5

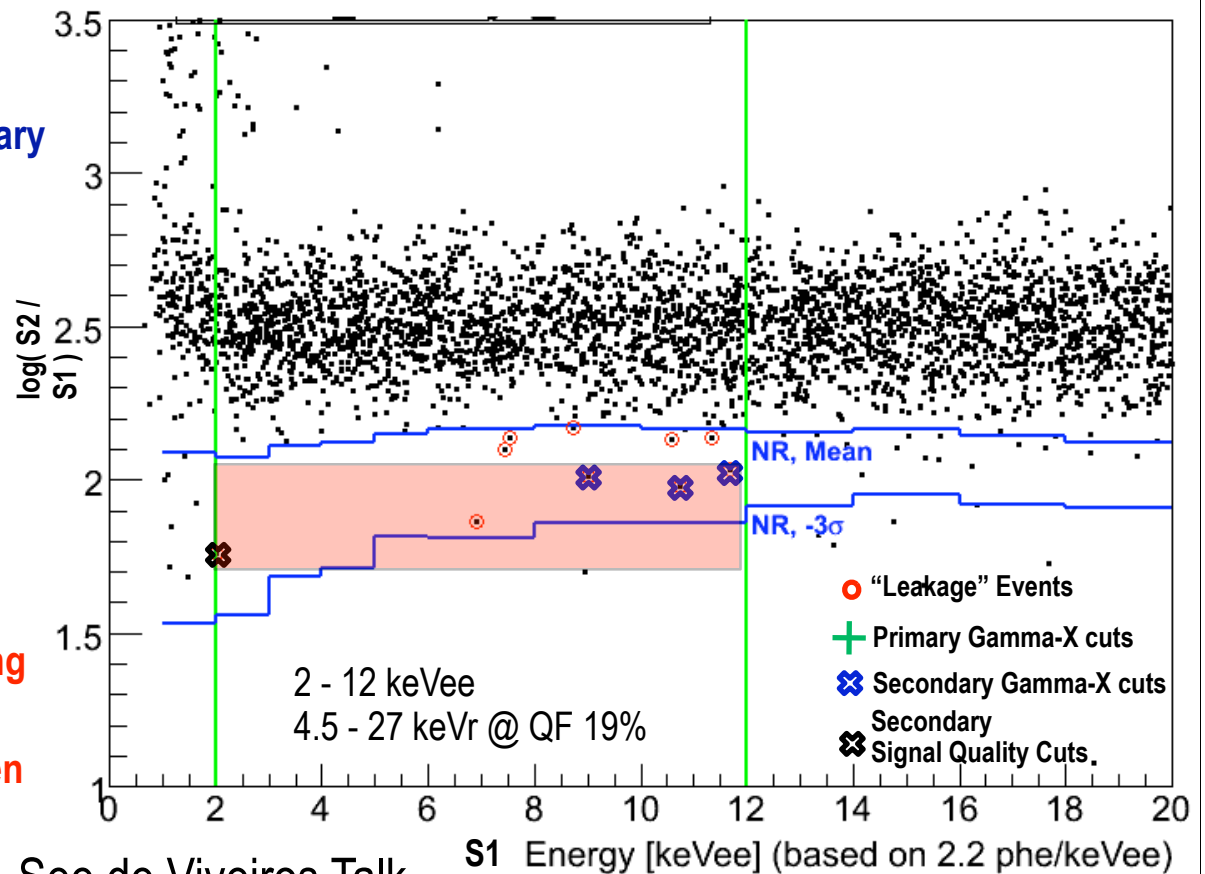

See de Viveiros Talk

S1 Energy [keVee] (based on 2.2 phe/keVee)

Absence of Low Energy Candidate Events (2-7 keVee)

§ Why are there fewer events in box in low energy?

§ Discrimination improves ! at lowest energies - NR and ER bands move apart in $\log(S2/S1)$ plot

§ Missing S2 events less frequent for low energies, (multiple scatters, boost S1)

de Viveiros Talk

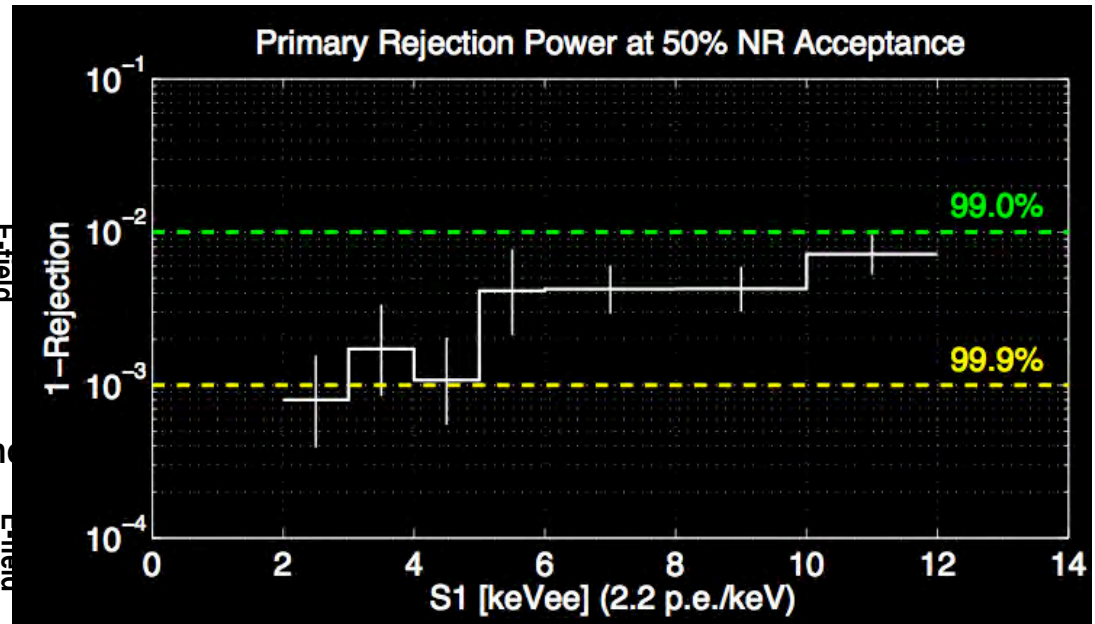
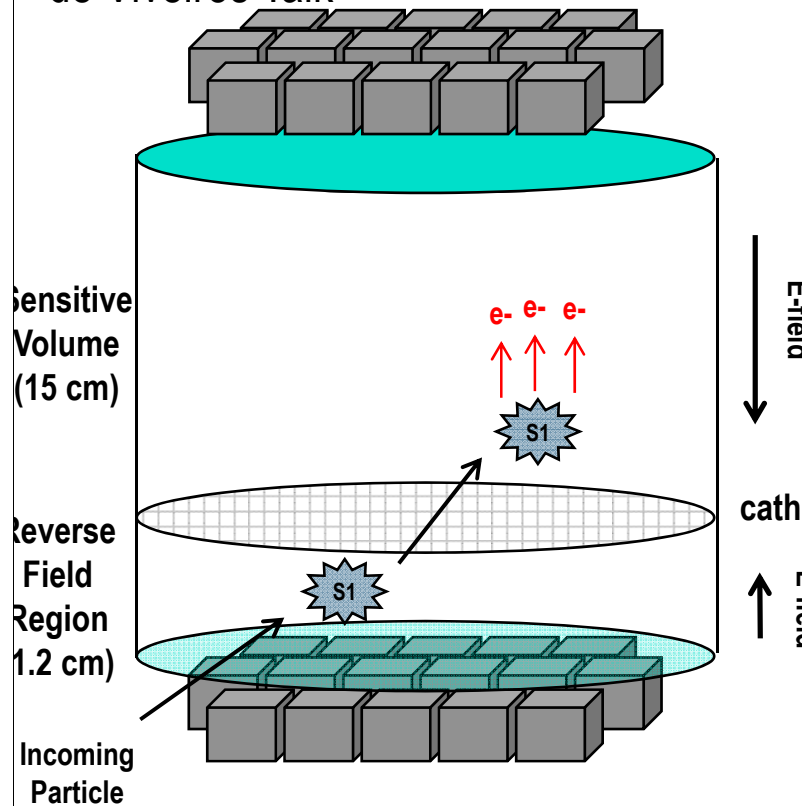

Manalaysay Talk

Setting Limit

- Effect on dm sensitivity associated with varying assumption of “best fit” to nuclear recoil light yield

- Low energy QF: assume 19% constant as default
- Also consider low energy asymptote $>30\%$ - $<10\%$

Yellin Maximum Gap Analysis

PRD 66 (2002) 032005

Allows fit to Sig+Known BG+Unknown BG

XENON10 (w Yellin Maximum Gap Meth.)

070412v4 dtj/rjg

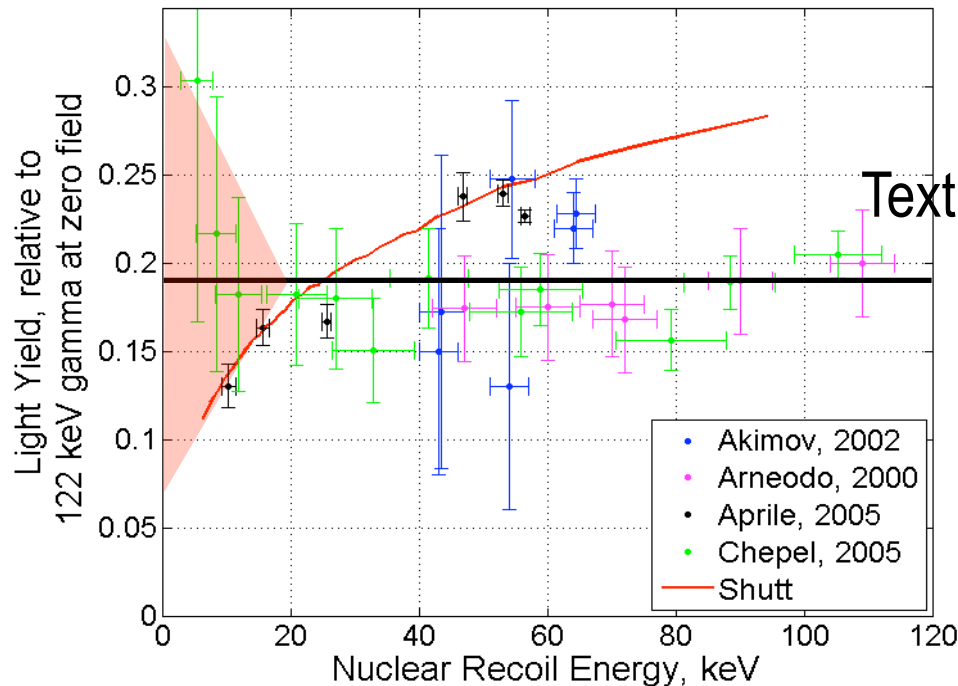

See Dahl Talk

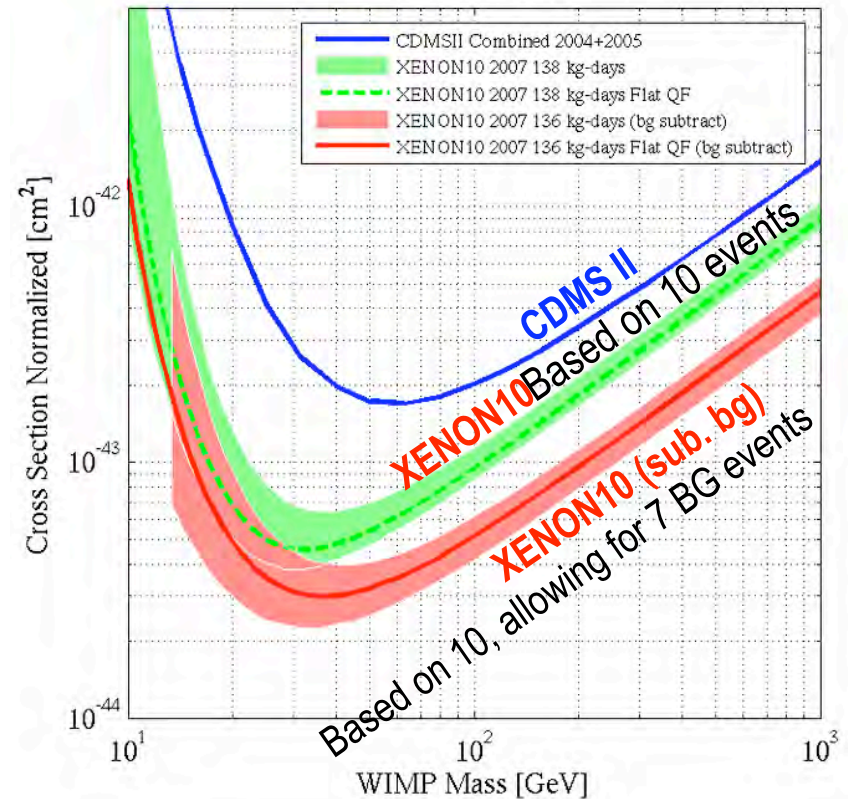

XENON10

- In situ Neutron Calibration agreed very closely with calibrations of above ground prototypes.
- High Stats Gamma Calib and Preliminary non-blind WIMP search (20 live days) shows performance very similar performance
- Discrimination (S2/S1) - Behavior very encouraging
 - Gaussian Component
 - Due to Recombination fluctuations, and Poisson stats at lowest energies (<5 keVee)
 - Non-gaussian (systematics) Contribution
 - Non-gaussian “LOW TAIL” component is being eliminated at better than 1000:1
 - Tail events removed using cuts tuned on gamma calib (but this is NON blind analysis)
 - Main Cuts used to
 - Fiducial Volume - eliminate events at edge Teflon where charge (S2) collection is poor
 - More than one S2 pulse indicating multiple scatter
 - S1 light hit pattern unusual - e.g. if most of signal is concentrated in few adjacent bottom PMTs, indicates additional scattering in Xe below cathode grid

LUX Dark Matter Experiment - Summary

- Brown [Gaitskell], Case [Shutt], LBNL [Lesko], LLNL [Bernstein], Rochester [Wolfs], Texas A&M [White], UC Davis [Svoboda/Tripathi], UCLA [Wang/Arisaka/Cline]
 - XENON10, ZEPLIN II (US) and CDMS; ν Detectors (Kamland/SuperK/SNO/Borexino); HEP/ γ -ray astro
 - (Also ZEPLIN III Groups after their current program trajectory is established)
 - Co-spokespersons: Shutt (Case)/Gaitskell (Brown)
- 300 kg Dual Phase liquid Xe TPC with 100 kg fiducial
 - Using conservative assumptions: >99% ER background rejection for 50% NR acceptance, $E > 10$ keVr
(Case+Columbia/Brown Prototypes + XENON10 + ZEPLIN II)
 - 3D-imaging TPC eliminates surface activity, defines fiducial
- Backgrounds:
 - Internal: strong self-shielding of PMT activity
 - Can achieve BG $\gamma + \beta < 7 \times 10^{-4}$ /keVee/kg/day, dominated by PMTs (Hamamatsu R8778 or R8520).
 - Neutrons (α, n) & fission subdominant
 - External: large water shield with muon veto.
 - Very effective for cavern $\gamma + n$, and HE n from muons
 - Very low gamma backgrounds with readily achievable $< 10^{-11}$ g/g purity.
- DM reach: 2×10^{-45} cm² in 4 months
 - Possible $< 5 \times 10^{-46}$ cm² reach with recent PMT activity reductions, longer running.

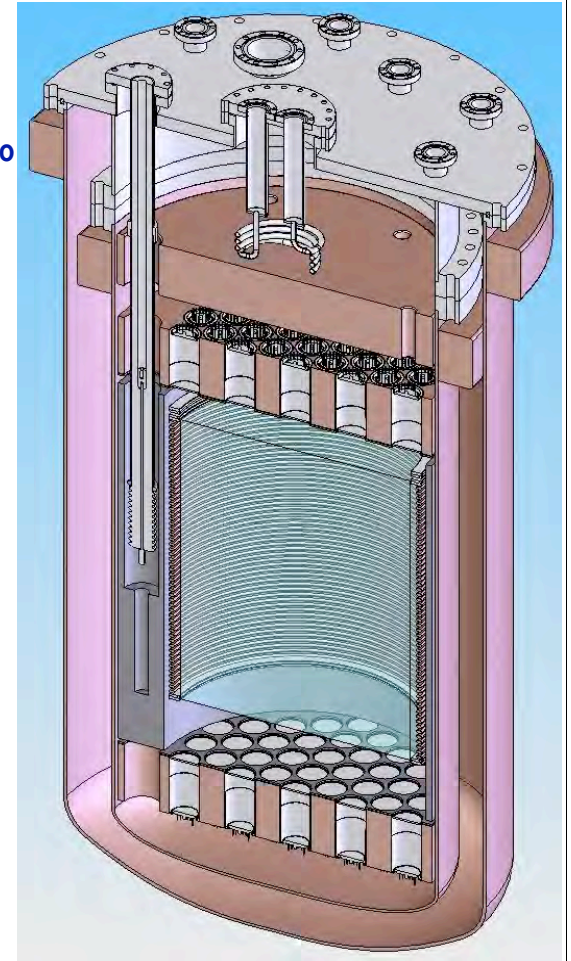

[http://
www.luxdarkmatter.org](http://www.luxdarkmatter.org)

Topology of Gamma Events That Deposit Energy in FV

- The rate of ER events in FV is determined by small angle scattering Compton events, that interact once in the FV
 - The rate of above events is suppressed by the tendency for the γ 's to scatter a second time. Either on the way in, or way out.
 - The chance of no secondary scatter occurring is more heavily suppressed the more LXe there is
 - The important optimization is to maximize the amount of LXe that lies along a line from the greatest sources of radioactivity (PMTs?) that pass through the FV.

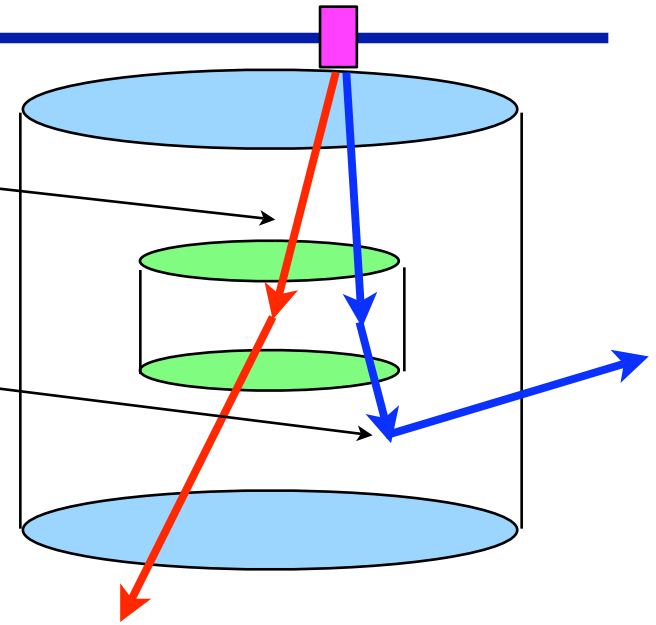

- Example for 1.5 MeV γ from outside LXe volume
 - Energy Spectrum for part of energy deposited in FV
 - Energy spectrum for all energy in detector
 - Additional application of multiple scatters cut has little additional effect on low energy event rate
- Conclusion for Event Suppression
 - xyz resolution of detector is important simply in defining FV. Little additional reduction from locating vertices.
 - (Full xyz hit pattern does assist in bg source identification)

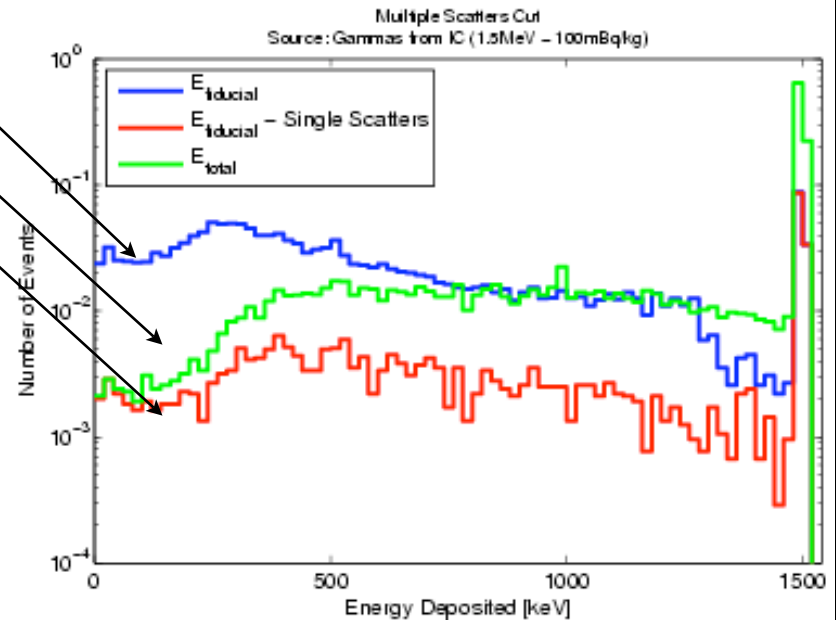

Scaling LXe Detector: Fiducial BG Reduction /1

- Compare LXe Detectors (factor 2 linear scale up each time)
15 kg (\varnothing 21 cm x 15 cm) \rightarrow 118 kg (\varnothing 42 cm x 30 cm) \rightarrow 1041 kg (\varnothing 84 cm x 60 cm)
 - Monte Carlos simply assume external activity scales with area (from PMTs and cryostat) using XENON10 values from screening

Low energy rate in FV before any ER vs NR rejection /keVee/kg/day

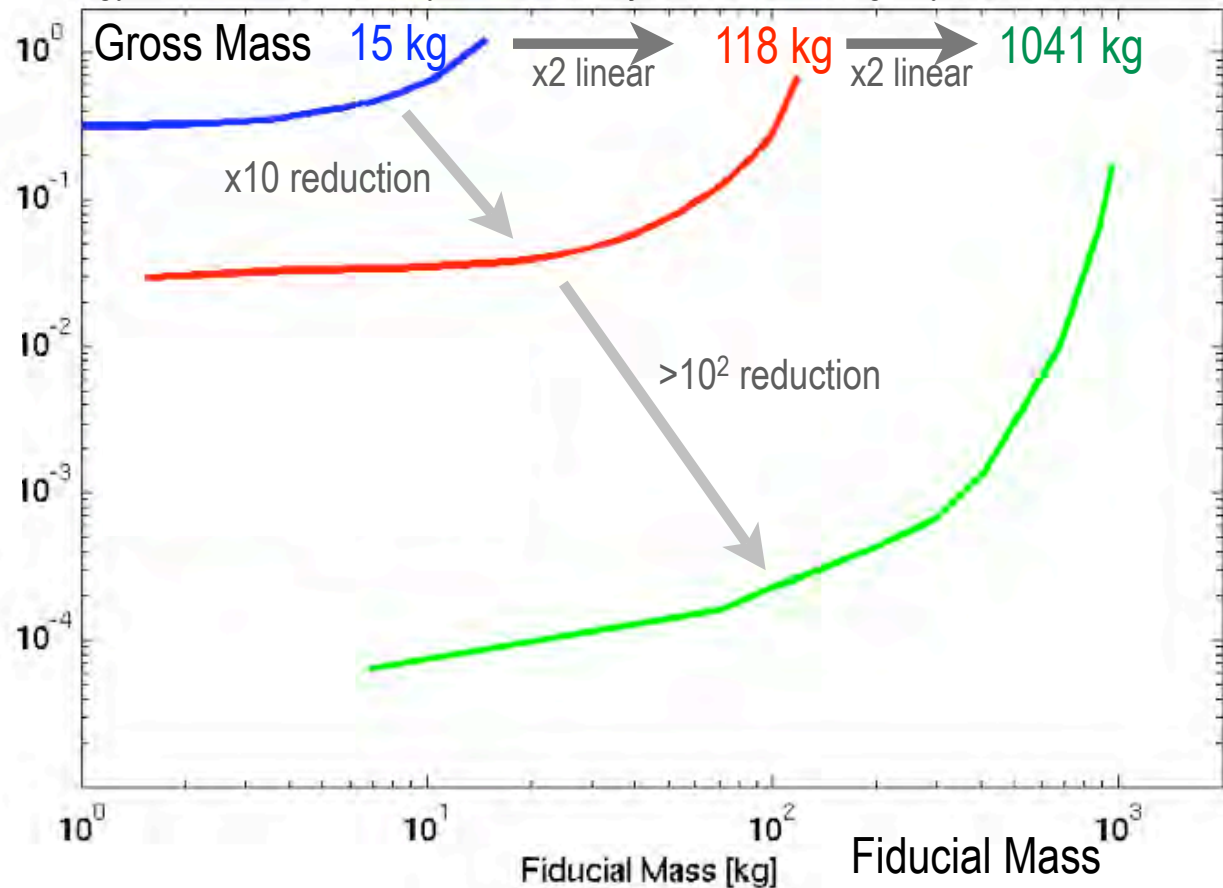

LUX program: exploit scalability

- **LUXcore: Final engineering for large-scale detector**
 - Cryostat, >100 kV feedthrough, charge drift, light collection over large distance
 - Full system integration, including ~1m water shield
 - 40 kg narrow “core”, 14 PMTs, 20 cm Ø x 40 cm tall.
 - Radial scale-up requires full-funding.
 - Under construction, Jan 2007, operations at Case: spring 2007.

LUX Experiment

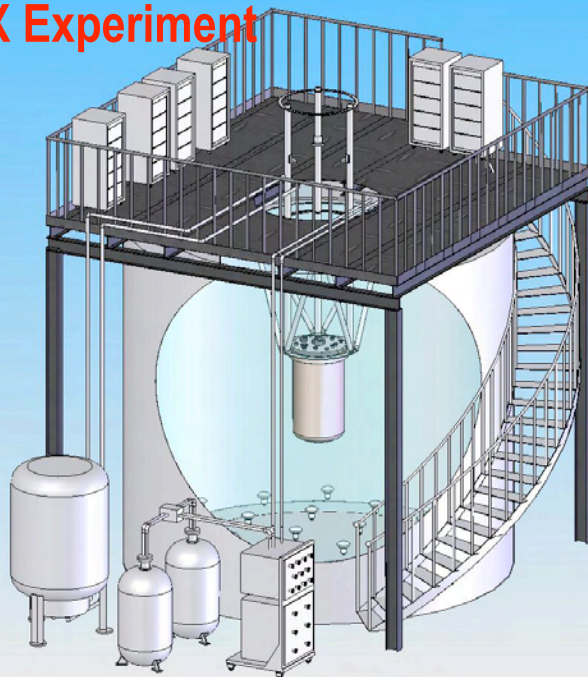

LUX detector

LUXcore

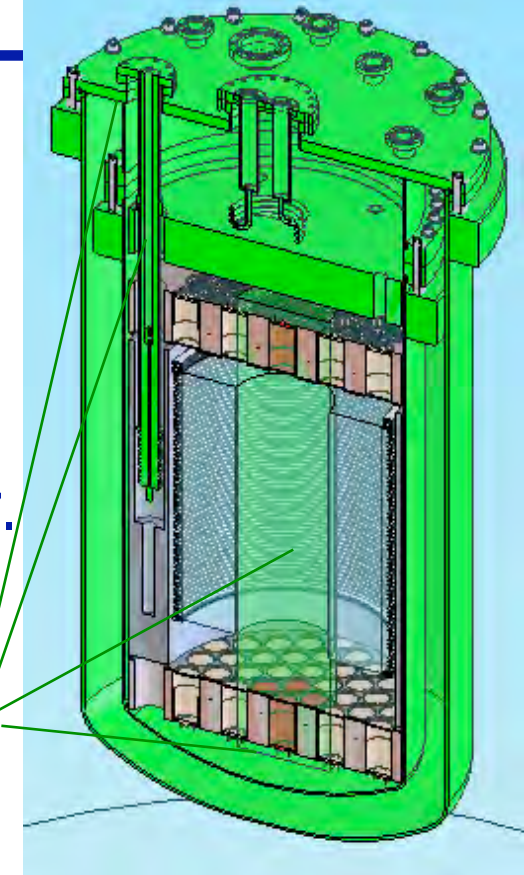

- LUX in ~ 6m Ø water shield
- Very good match to early-implementation DUSEL (e.g., Homestake “Davis” cavern)
 - SNOLAB LOI
- System scalable to very large mass.

Water Shield - Homestake - Davis Cavern

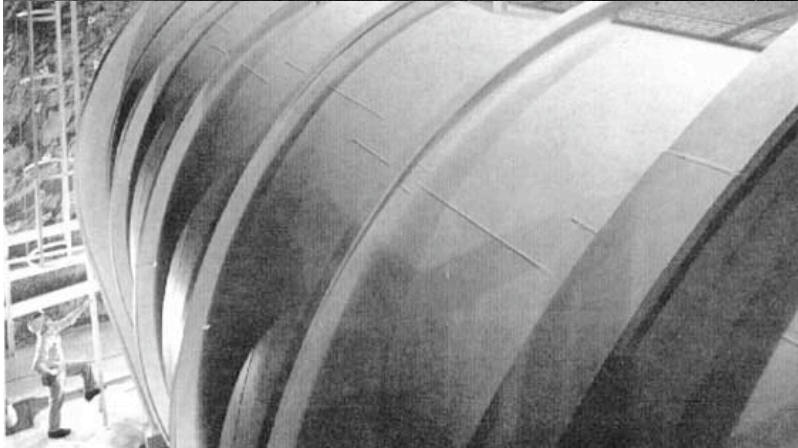

LUX Dark Matter Collaboration

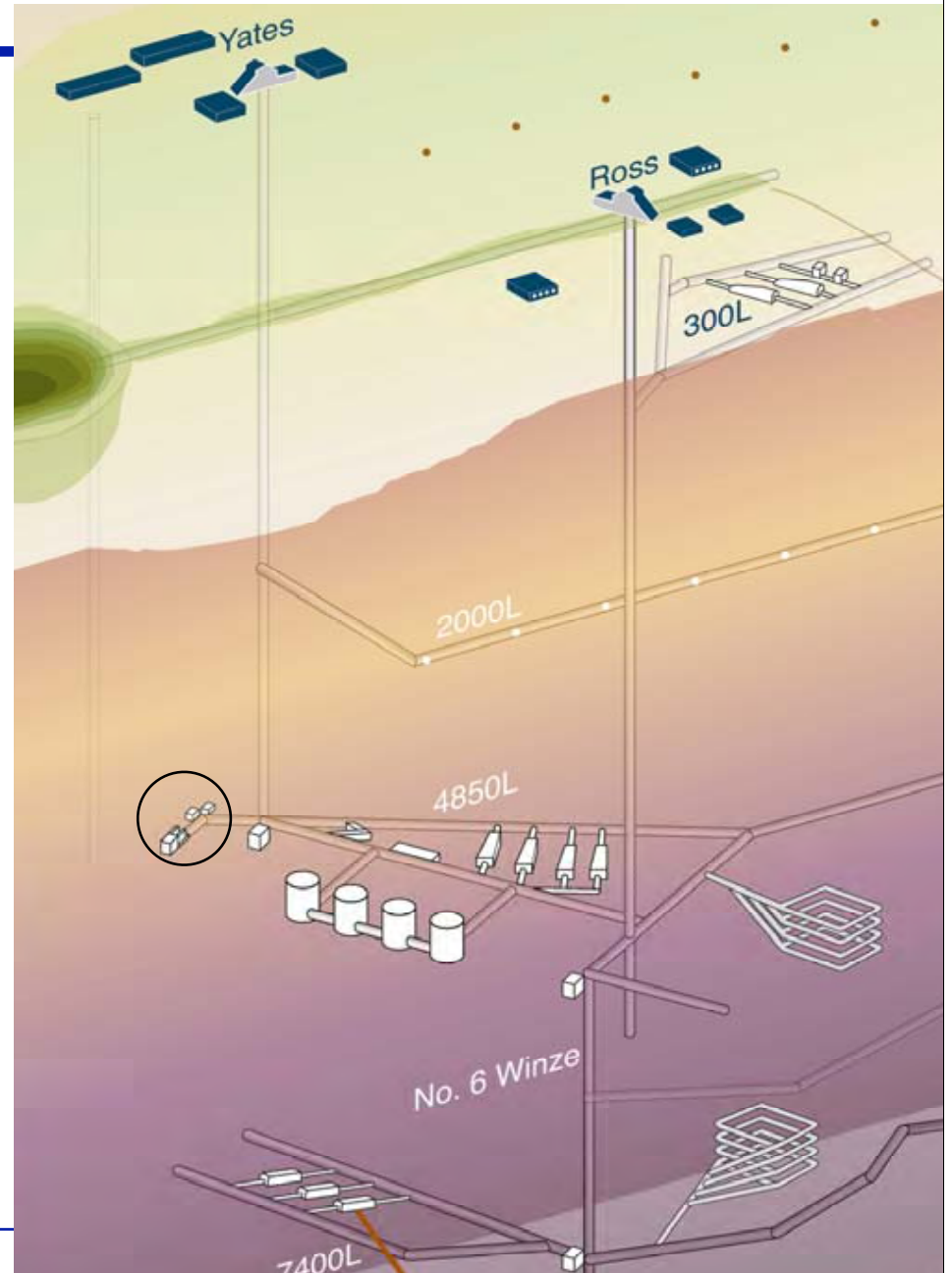

Homestake / Potential DUSEL Site (Lesko, LBL)

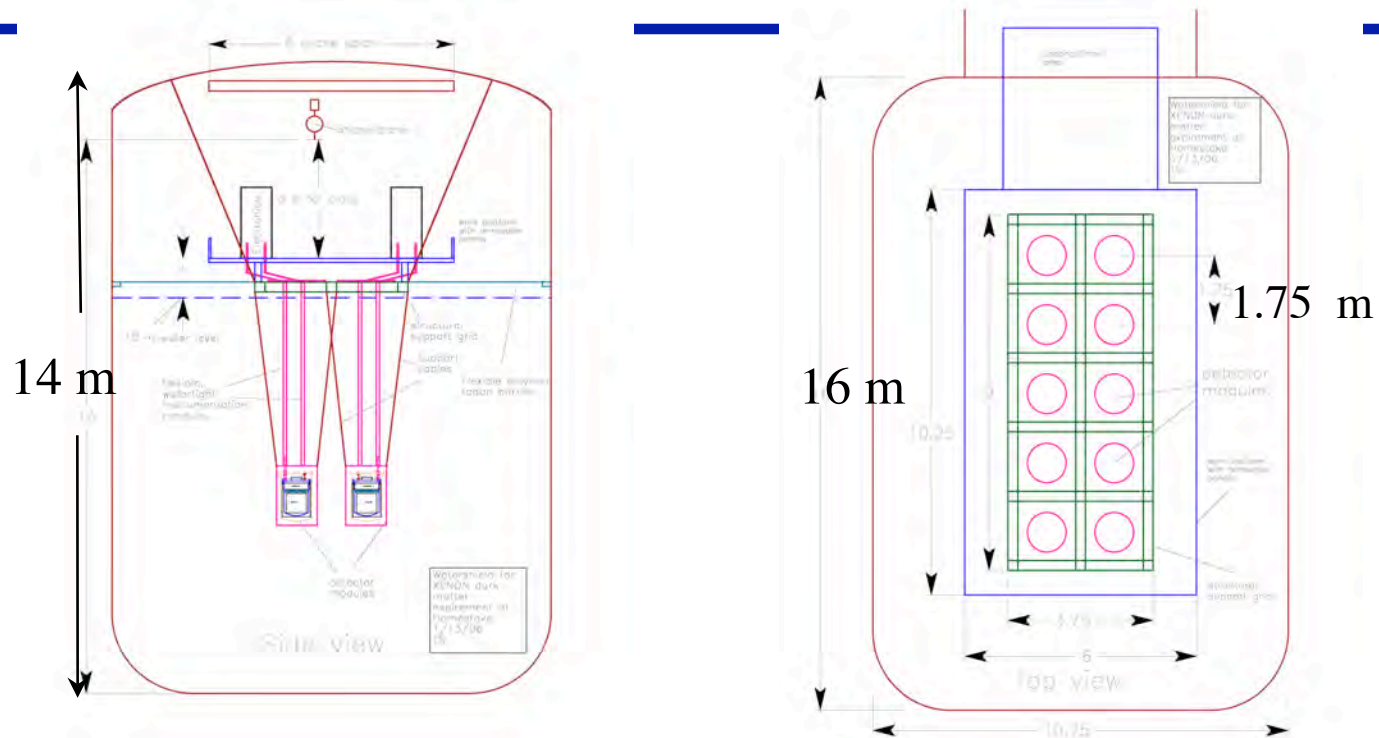

- DUSEL process for new national underground lab.
 - Site Decision mid 2007 (Full DUSEL lab 2010->)
- 4850 mwe depth at Homestake - early program.
- Water Shield: >4 m shielding / 10 module system

Dark Matter Results and (some of Goals)

• Dark Matter Goals

◦ LUX - Sensitivity curve at $2 \times 10^{-45} \text{ cm}^2$ (100 GeV)

- Exposure: Gross Xe Mass 300 kg
Limit set with **120 days running**
x 100 kg fiducial mass x 50% NR acceptance
 - If candidate dm signal is observed, run time can be extended to improve stats
- ~1 background event during exposure assuming most conservative assumptions of ER 7×10^{-4} /keVee/kg/day and 99% ER rejection
 - ER bg assumed is dominated by **guaranteed** Hamamatsu PMT background (R8778 or R8520) recent PMTs from Hamamatsu achieving lower backgrounds, but not guaranteed
 - Improvements in PMT bg (and rejection power) will extend background free running period, and DM sensitivity

◦ Comparison

- SuperCDMS Goal @ SNOLab: Gross Ge Mass 25 kg (x 50% fid mass+cut acceptance)
Limit set for **1000 days running** x 7 SuperTowers

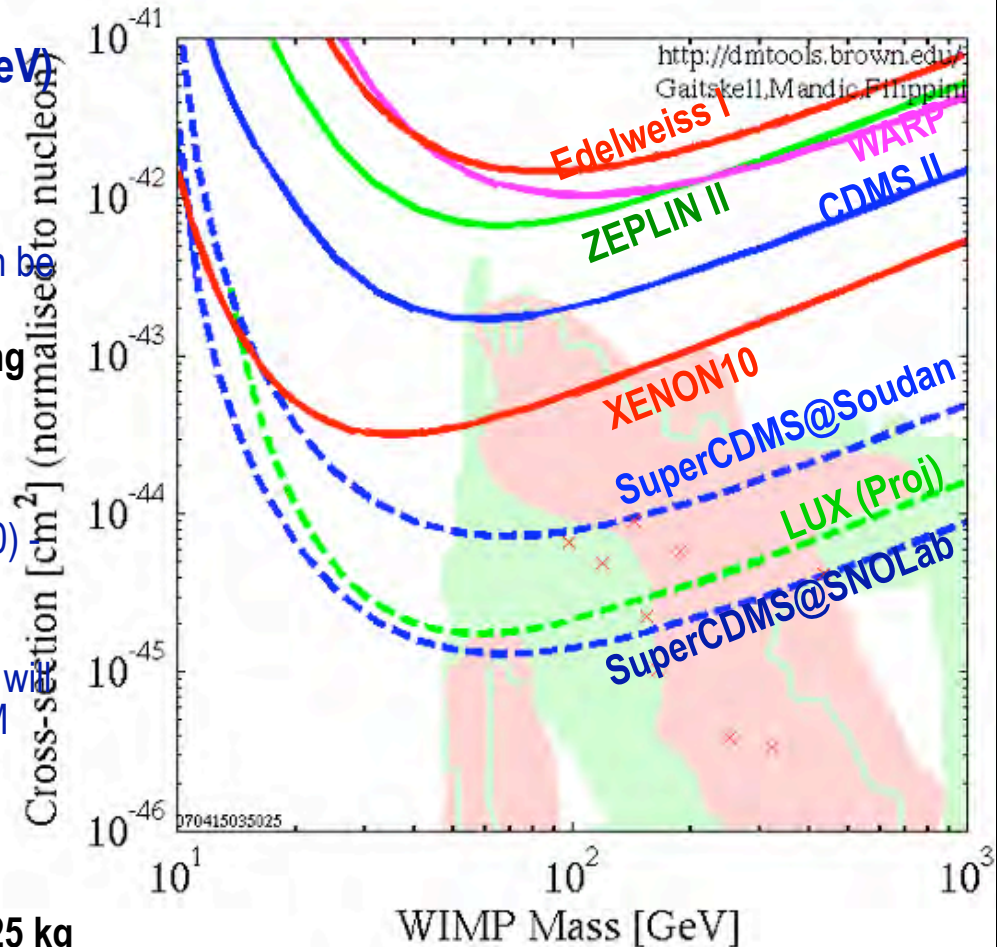

Noble Liquids for Dark Matter

• Summary

- Past two years we have seen rapid progress in demonstrated performance (NR-ER discrimination/energy resolution/light yields) of Noble Liquid Detectors in low energy regime
- Competitive WIMP Search Results from WARP (Ar), ZEPLIN II (Xe), XENON10 (Xe)

• Single Phase (Liquid only) - Pulse Shape Discrimination (ER)

- Ar/Ne demonstrating $>10^5:1$ discrimination at 50 keVr, limitations not fundamental.
 - Will push these tests to $10^8:1$ using higher light yields/shielding in test facilities (required for 10^{-45} cm² dm reach)
- Position reconstruction based on photoelectron hit patterns (timing not useful in ≤ 10 tonne scale). Misreconstruction
 - ³⁹Ar (160 evts /keVee/kg/day) / Rn daughters on surfaces (major issue)

• Dual Phase (Liquid Target/Ioniz Readout in Gas) - Discrim. Ionization/Photons+PSD (Ar)

- Xe TPC Operation: ZEPLIN II / XENON10 (20-35 kg target)
 - Discrimination established $\sim 10^2:1$ (50% NR acceptance), fiducialize to get further bg reduction
 - Xe intrinsically very low activity (cf XMASS) , so scaling works
- Ar TPC (WARP) - studying use of Ionization + PSD
 - Discrimination Ionization $\sim 10^2:1$ + PSD $>10^4:1$ (energy threshold should be improved with better elec.)

• Scaling of Technology

- Detector WIMP sensitivity improves very significantly with size
- Designs are very scalable - 1 event/100 kg/month (10^{-45} cm²) in a few years seems very realizable
- Future instruments for 10^{-46} – 10^{-47} cm² also realistic (performance & cost)